

## Nanchang Q-5 Fantan

In 1961 in China was started production of MiG-19 jet fighter/Soviet licence/, also named F-6. In the first half of 70's Chinese constructors from aviation factory in Nanchang were designed new aircraft Q-5/also named A-5/, which was developed from F-6. The Q-5 had new fuselage's nose, especially changed were air intakes. New machine was powered by Wopen WP-6 engine, which was licence version of Soviet engine RD-9BF. The Q-5 was machine prepared for attacking ground targets and had 4 pylons for drop tanks, bombs, rockets and rocket pods.

In 1977 Q-5s were posted to combat units of Chinese Air Force and Chinese Navy. In this time was designed new version of Q-5, which had additional pylons under fuselage. In 1979 Q-5s were used during the war between Vietnam and China. In 1980/81 China was furnished 65 Q-5s to Pakistan Air Force. This machine is still in production, but in new versions: Q-5C, Q-5K and Q-5M.

Im Jahre 1961 begann China mit der Produktion des Jagdflugzeugs MiG-19, als F-6 bezeichnet, nach sowjetischen Lizenzen. In der ersten Haelften der 70er Jahre gingen chinesische Konstrukteure der Flugzeugwerke in Nanchang an die Weiterentwicklung der F-6 zum Jagdbomber Q-5, auch als A-5 bezeichnet. Veraendert wurde vor allem der Rumpfbau einschliesslich der Lufteinlaeuft. Als Treibwerke kamen zwei Axialturbinen Wopen WP-6, Lizenzbau des sowjetischen RD-9BF, zum Einbau. Unter den Tragflaechen befinden sich vier Aufhaengpunkte, die beiden aeusseren fuer je einen 400-Liter-Kraftstoffzusatzbehaelter, die inneren fuer Bomben, Raketen oder Raketenbehaelter.

1977 wurde die Q-5 in die Bewaffnung aufgenommen. Noch waehrend Ausruestung der chinesischen Luftstreikraefte und Marineflieger erschien eine neue Version mit vier weiteren Aussenaufhaengungen fuer Waffenlasten unter dem Rumpf. Im vietnam-chinesischen Konflikt 1979 wurden Q-5 benutzt. 1980/81 lieferte China 65 Q-5 an die pakistanische Luftwaffe. Auch andere Version: Q-5C, Q-5K und Q-5M sind bekannt. Das Muster ist bisher bereits in beachtlichen Stueckzahlen produziert worden.

### Nanchang Q-5- technical data-technische Daten

span-Spannweite	- 9,7 m
length-Laenge	- 15,4 m
weight-Masse	- 6635 kg
max speed-Hoestgeschwindigkeit	- 1200 km/h
service ceiling-Gipfelhoehe	- 16000 m
range-Reichweite	- 1250 km

## Nanchang Q-5I Fantan

People's Liberation Navy Air Force - 14th Regiment - 5th Division  
Qingdao Naval AB - North Sea Fleet

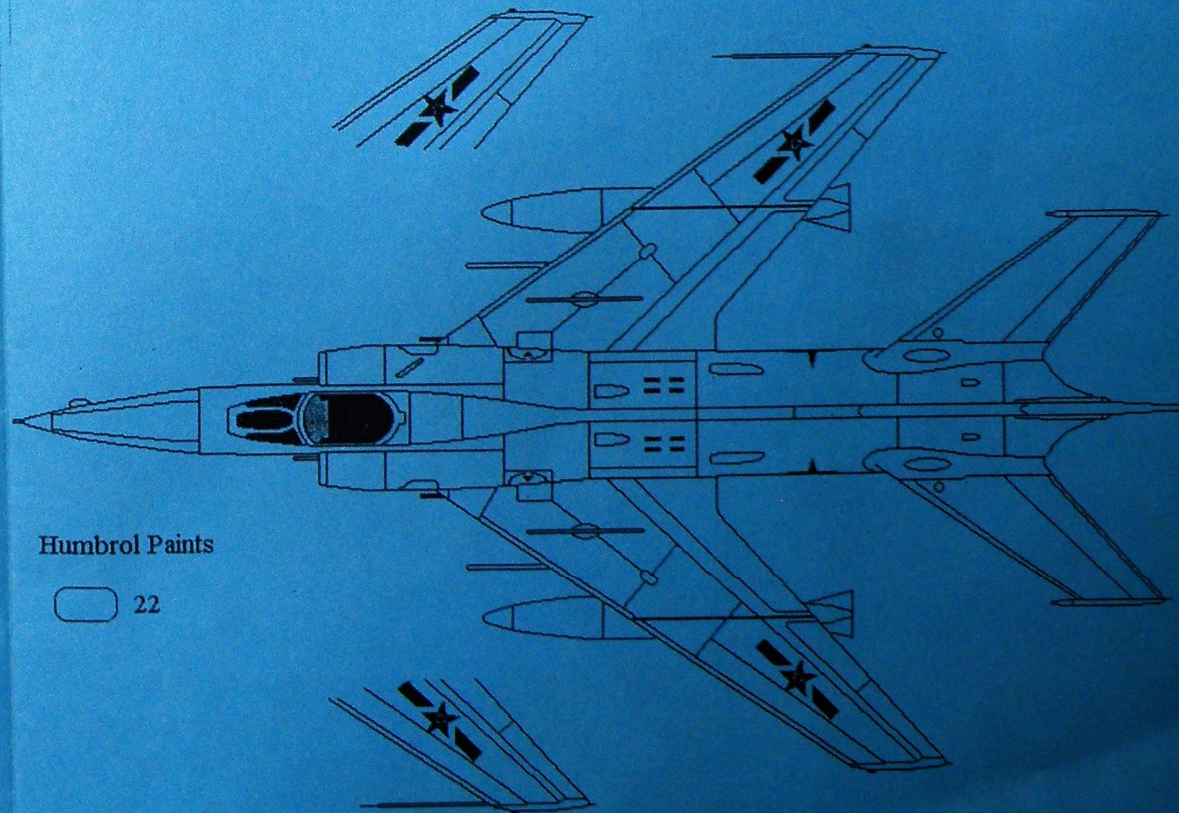
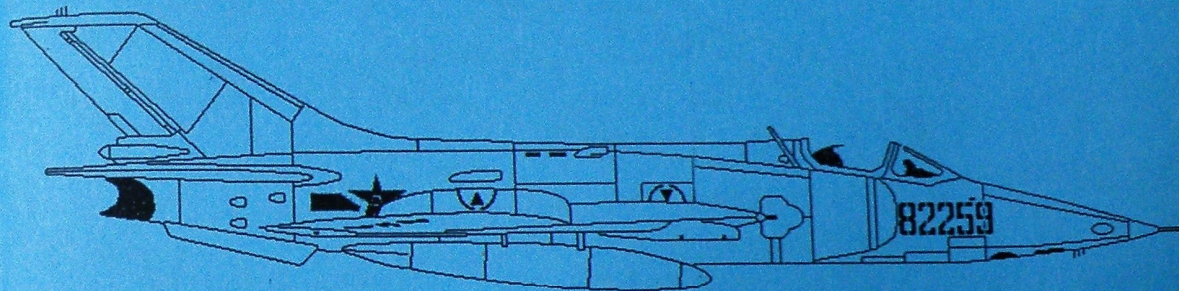
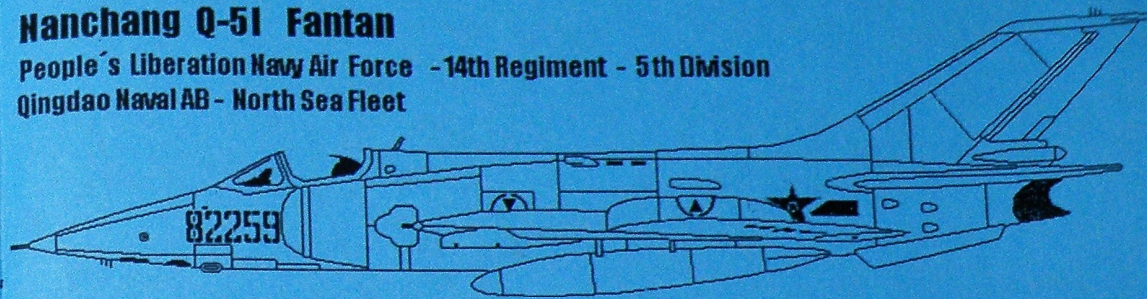

Humbrol Paints

○ 22



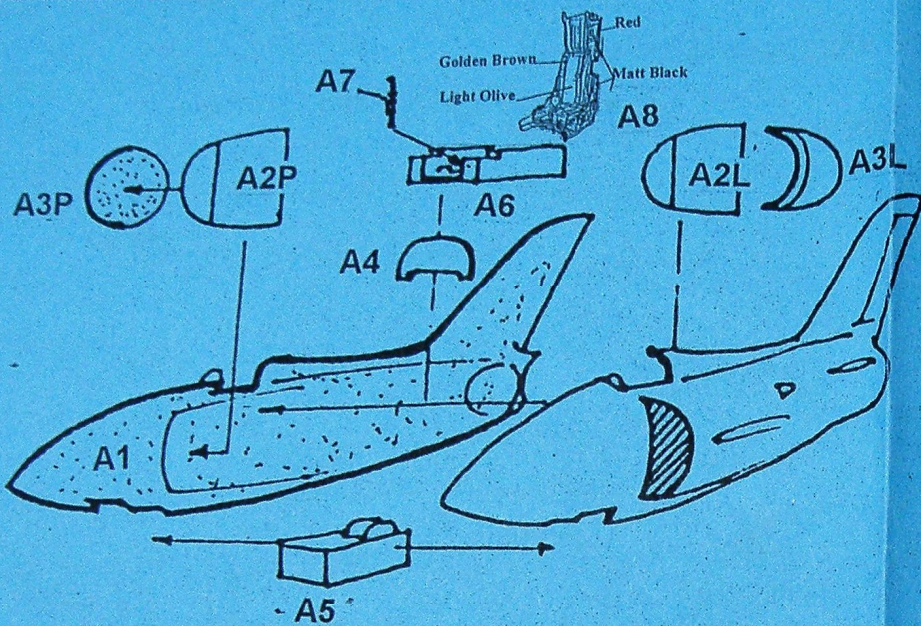

1 2

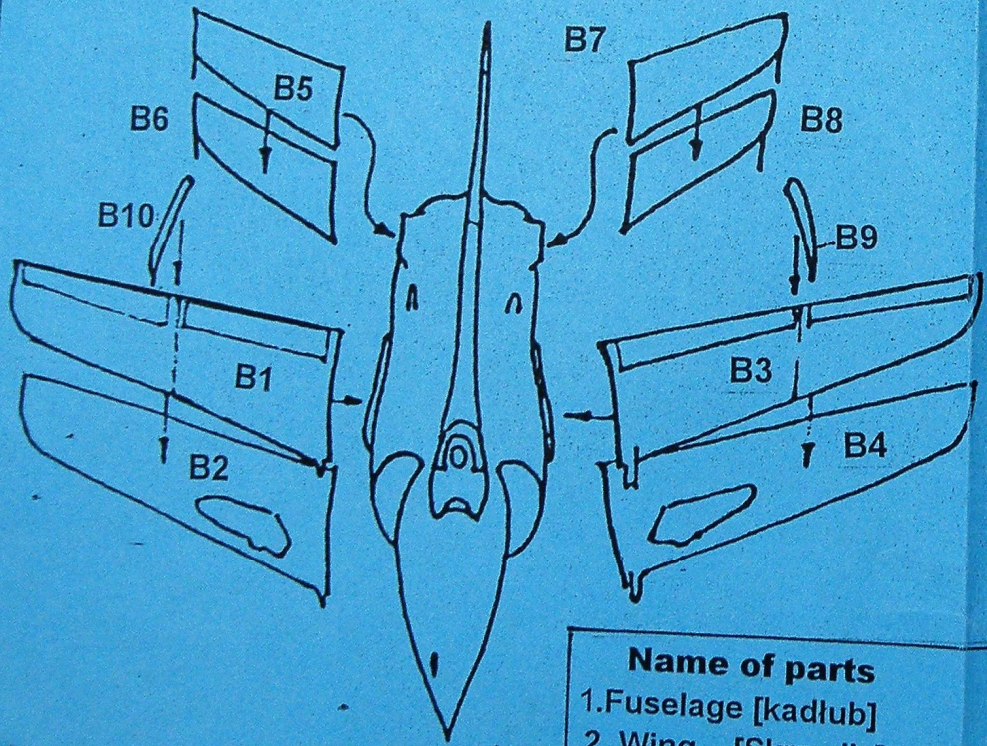
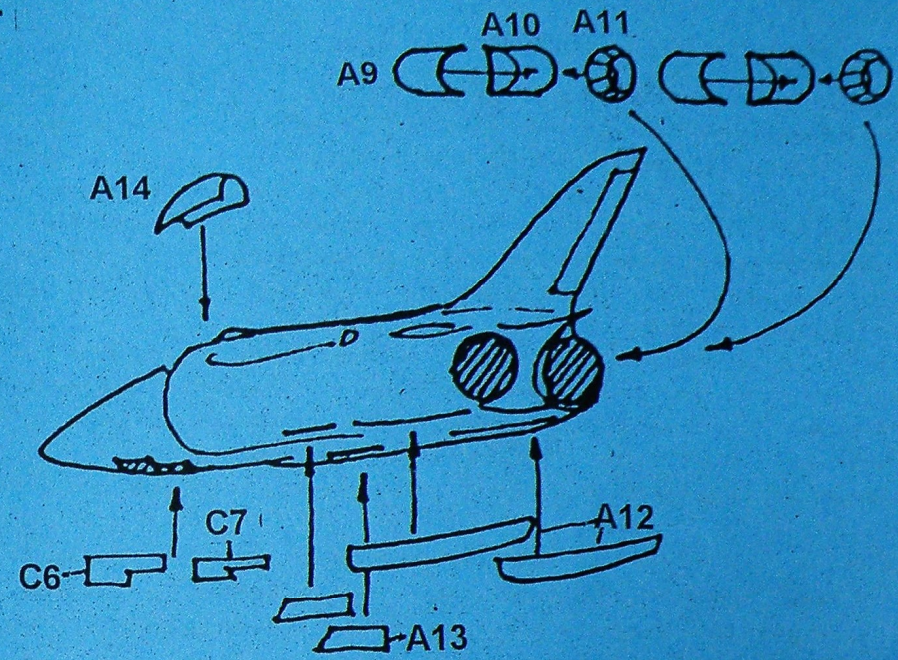

3 4

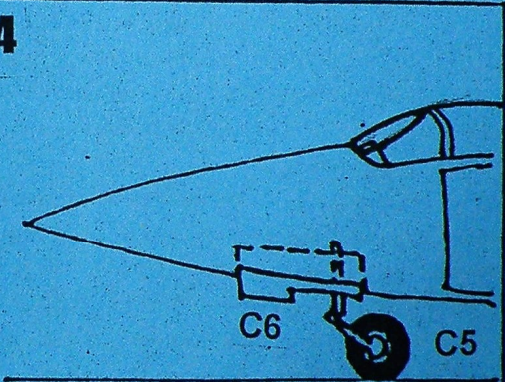

5

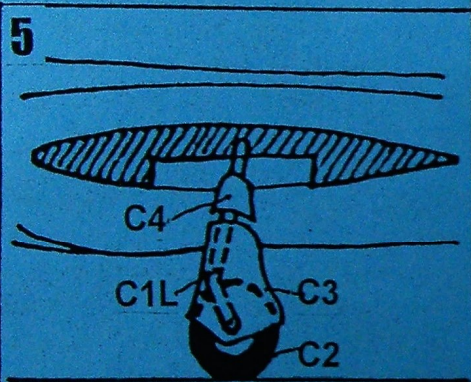

6

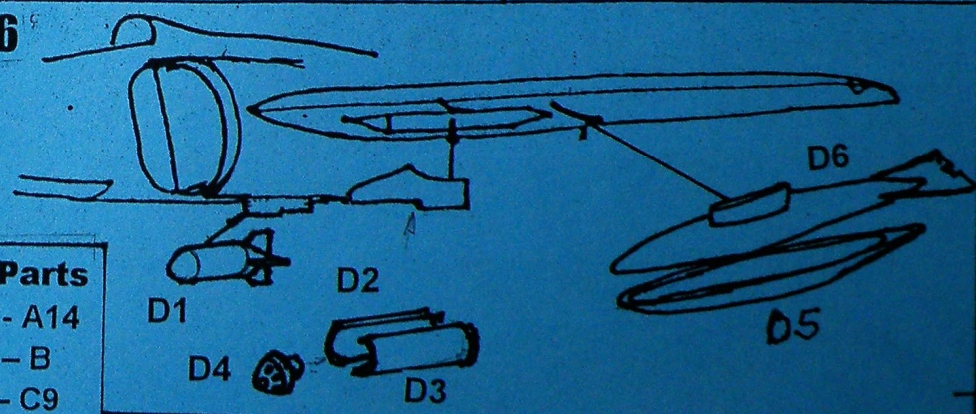

Name of parts	No. Parts
1. Fuselage [kadłub]	A1 - A14
2. Wing [Skrzydła]	B1 - B
3. Udercarriage [podwozie]	C1 - C9
4. Wapons [uzbrojenie]	D1 - D6



# Nanchang Q-5/A-5 Fantan

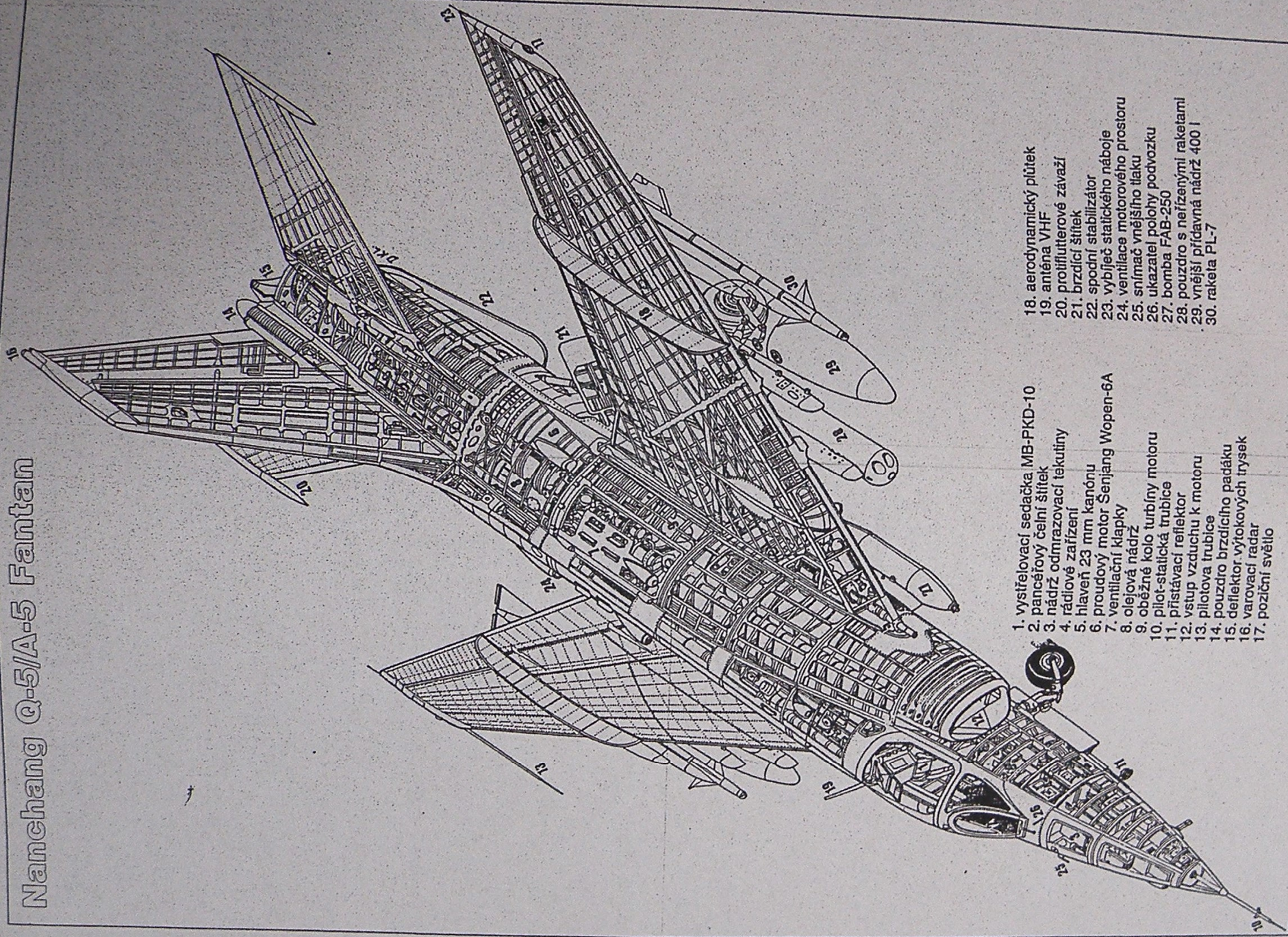

1. vysílovací sedačka MB-PKD-10
2. pancéřový čelní štítek
3. nádrž odmrazovací tekutiny
4. rádiové zařízení
5. hlavěň 23 mm kanónu
6. proudový motor Senjang Wopen-6A
7. ventilační klapky
8. olejová nádrž
9. oběžné kolo turbíny motoru
10. pilot-statická trubice
11. přistávací reflektor
12. vstup vzduchu k motoru
13. pilotova trubice
14. pouzdro brzdícího padáku
15. deflektor výtokových trysek
16. varovací radar
17. poziční světlo

18. aerodynamický plůtek
19. anténa VHF
20. protifluterové závaží
21. brzdící štítek
22. spodní stabilizátor
23. vyběječ statického náboje
24. ventilace motorového prostoru
25. snímač vnějšího tlaku
26. ukazatel polohy podvozku
27. bomba FAB-250
28. pouzdro s nefřízenými raketami
29. vnější přídavná nádrž 400 l
30. raketa PL-7



# Nanchang A-5C Fantan

Pakistan Air Force - 32 Wing - 7th Sqn 'Bandits' - Masroor AB

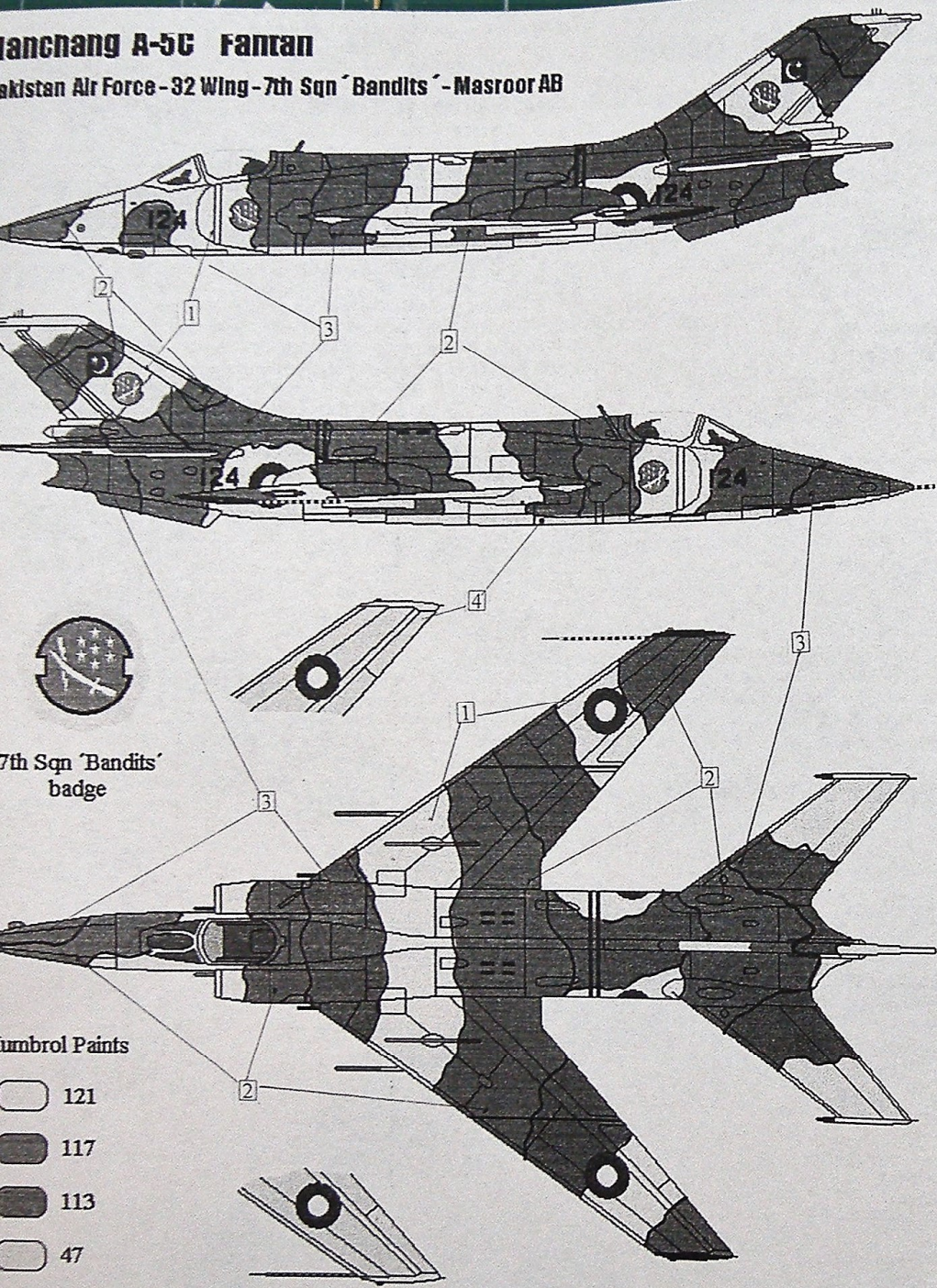

### Humbrol Paints

- 121
- 117
- 113
- 47

Nanchang Q-5/A-5 Fantan - Pakistan

# Nanchang Q-5 Fantan

People's Liberation Army Air Force - 83rd Regiment - 28th Division  
Hangzhou Jianqiao AB - 1979

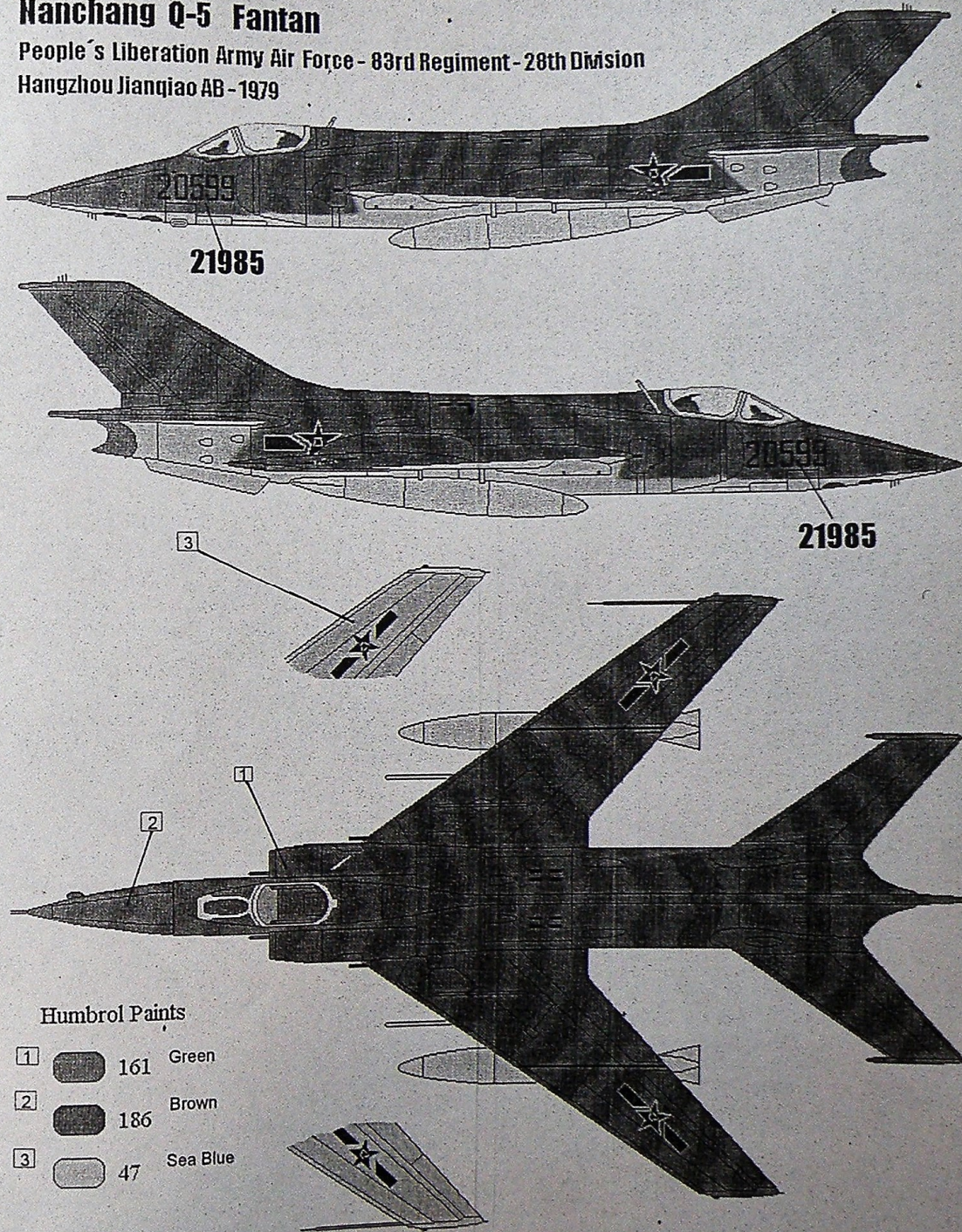

### Humbrol Paints

- 1 161 Green
- 2 186 Brown
- 3 47 Sea Blue



# Nanchang A-5C Fantan

Pakistan Air Force - 36th Wing - 26th Sqn 'Black Spiders' - Peshawar AB

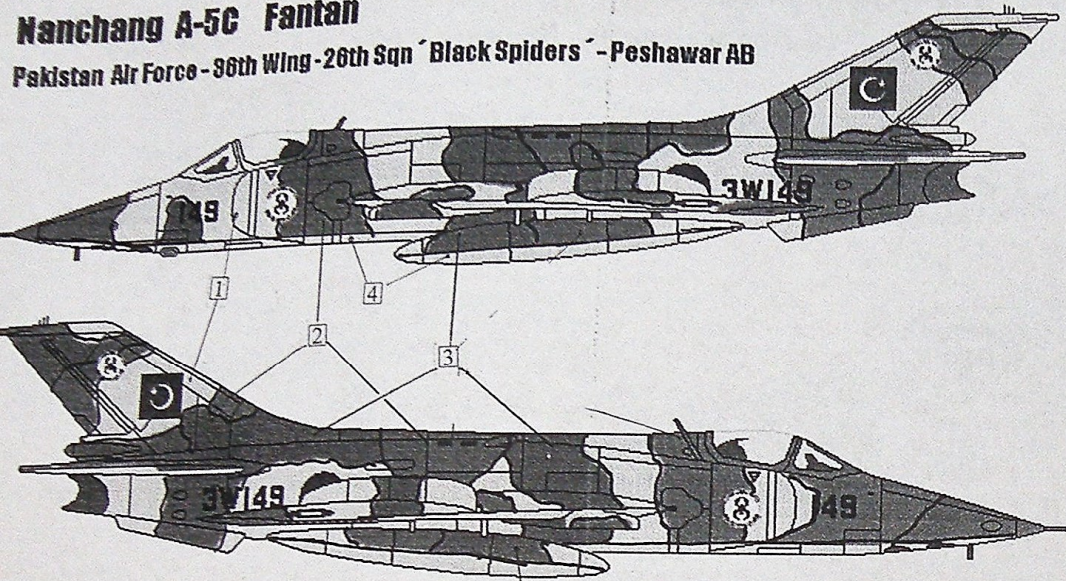

26th Sqn 'Black Spiders' badge

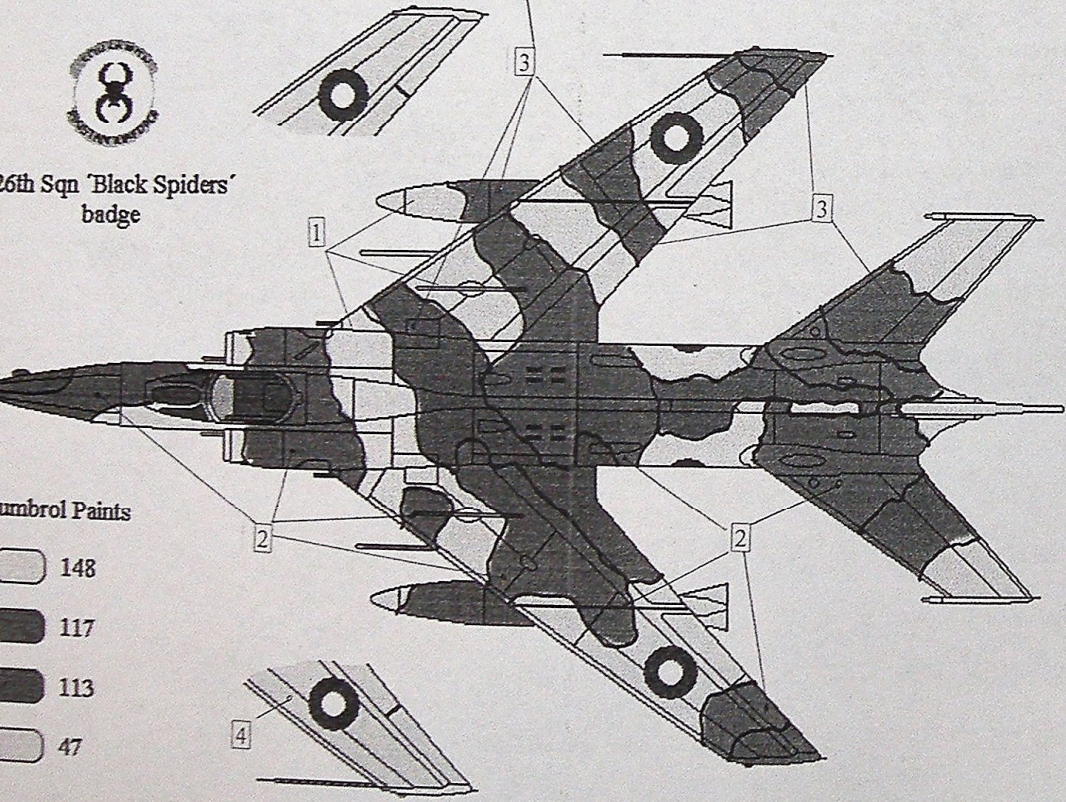

Humbrol Paints

- 148
- 117
- 113
- 47

Nanchang O-5/A-5 Fantan - Pakistan

# Nanchang Q-5 Fantan

People's Liberation Army Air Force - 50th Division

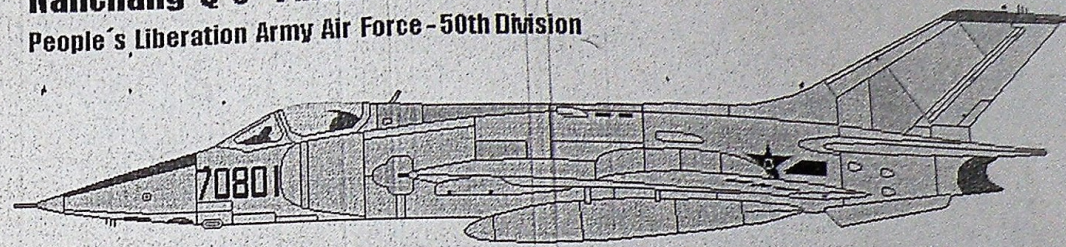

70801

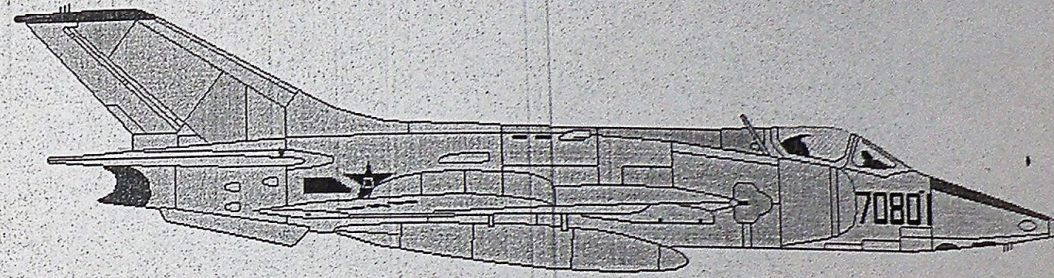

70801

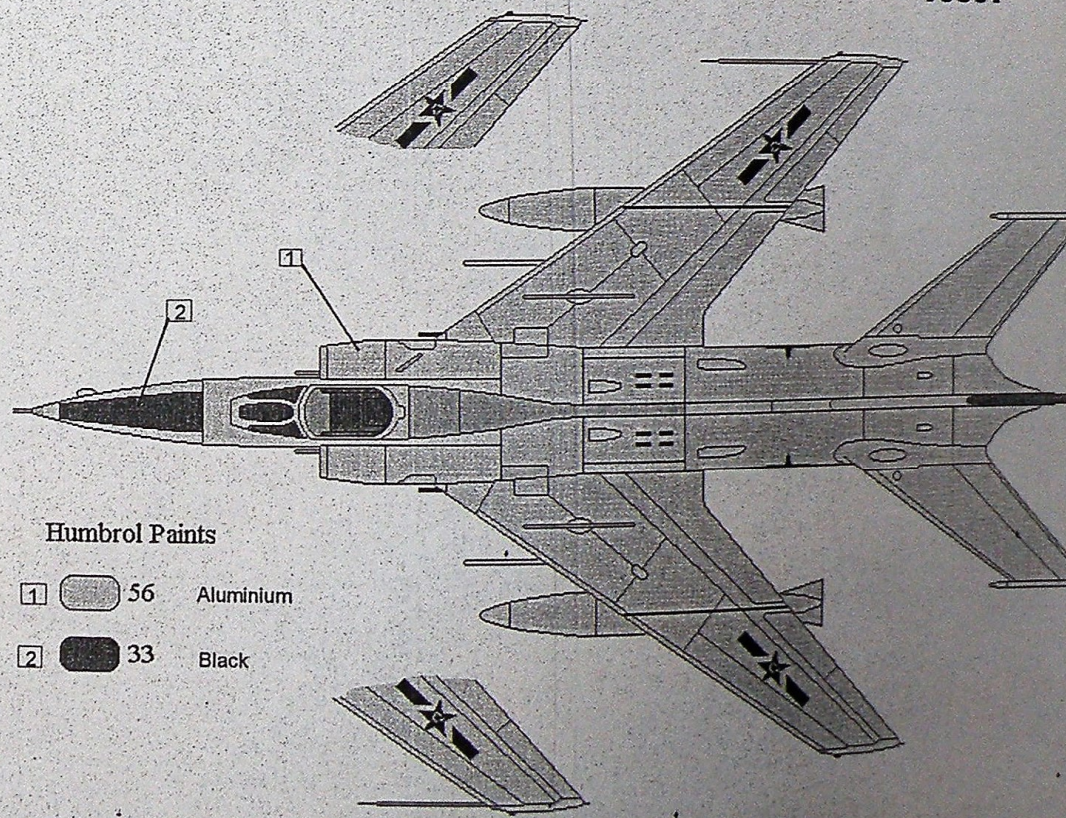

Humbrol Paints

- 1 56 Aluminium
- 2 33 Black