

**1:72 SCALE**

ITEM NO.:01661

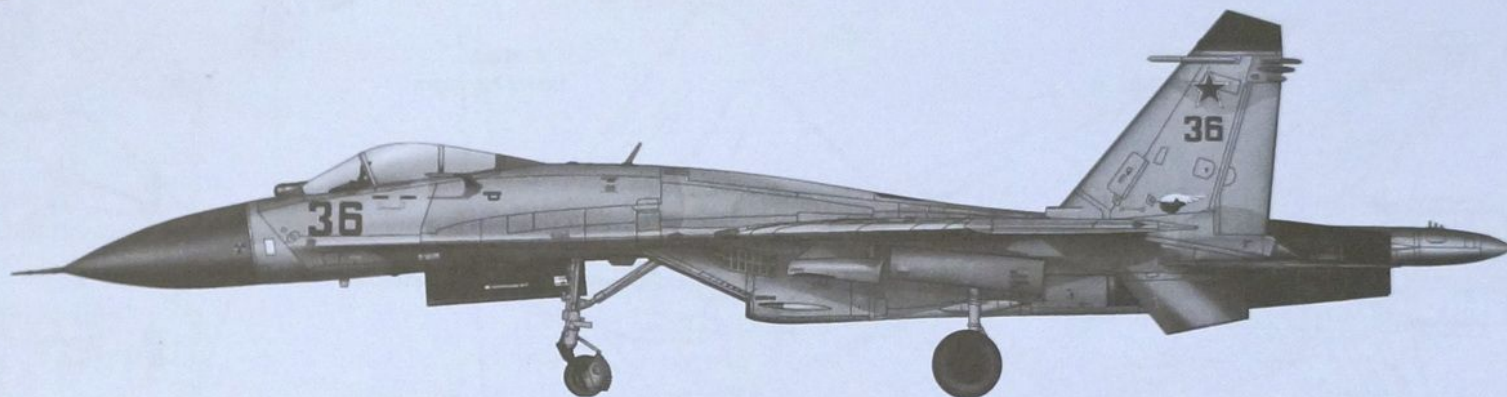

# Russian Su-27 Early type

俄罗斯苏-27早期型战斗机

## READ BEFORE ASSEMBLY:

- Study and understand these instructions thoroughly before beginning assembly
- When needed, remove photo-etch parts carefully using a modeling knife or photo etch sprue cutter, being careful not to damage or lose small parts.
- Take extra care in handling photo etch parts in order to avoid injury
- Apply instant cement sparingly to photo etch parts where instructed

- Tools recommended(not included in kit):Plastic and instant cements,sprue cutters,long nose pliers,modeling knife, small files, tweezers, pin vise & scissors. Soft cloth and sandpaper will also assist in construction
- Glue and paint are not included in the kit. Use plastic cement and hobby paints only. Color guide for purchasing paint is included in the kit.

## 装配之前仔细阅读

- 小心用模型锉刀锉平所有零件表面的注射浇口。
- 小心用刀片切下蚀刻片零件，不要遗失小零件。
- 用强力快干胶水粘合蚀刻片零件和金属轴。过量快干胶水使用可能导致可动零件会粘住，小心涂胶。
- 取蚀刻片时应特别注意安全，防止利边划伤手指。
- 某些零件表面需贴上水贴纸，请选择在装配的同时进行。
- 推荐模型工具(自备)：胶水，水口剪刀，长咀钳，刀片，锉刀，镊子，钳，钻，剪刀，瞬间快干胶。
- 软布同砂纸同时也应该是必备工具。
- 请使用塑料胶水和油漆，模型内不含。

## 水贴纸的使用:

1. 从水贴上剪下印花;
2. 将印花放入温水中浸10秒，然后放在干净布上。
3. 拿着印花纸板将印花移到模型上;
4. 手指蘸水将印花移到适当的位置;
5. 用软布轻压印花直至水干，气泡消失。

## DECAL APPLICATION:

1. Cut decals from sheet as needed
2. Dip the decal in warm water for about 10 seconds and then place on soft clean cloth.
3. Hold the decal backing sheet edge and gently slide the decal onto the model in its proper position.

4. While still wet,decal can be adjusted for better fit on model by dampening it gently with your finger.
5. When placed in the proper position,gently press decal down with a soft cloth until excess water and air bubbles are gone.
6. Allow decal to dry completely before handling model



cyanoacrylate glue  
使用强力胶



weight  
配重



make hole  
钻孔



cut / remove  
切除



option  
选择



no cement  
不涂胶水



decal  
贴纸



bend  
弯曲



file / sand  
锉平

部品图  
Parts

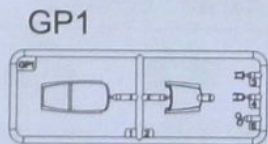
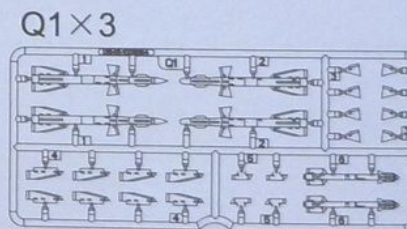
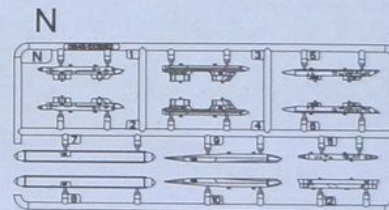
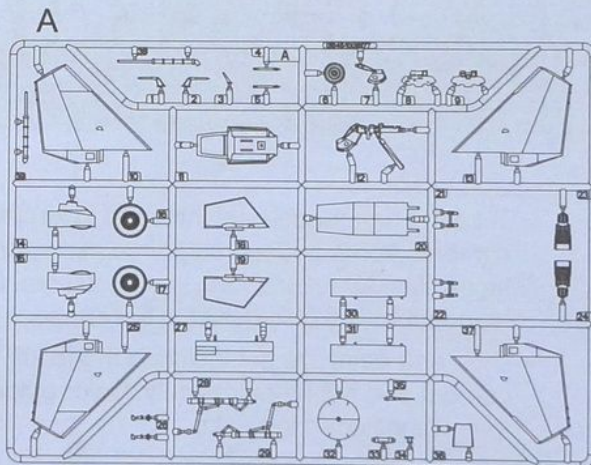
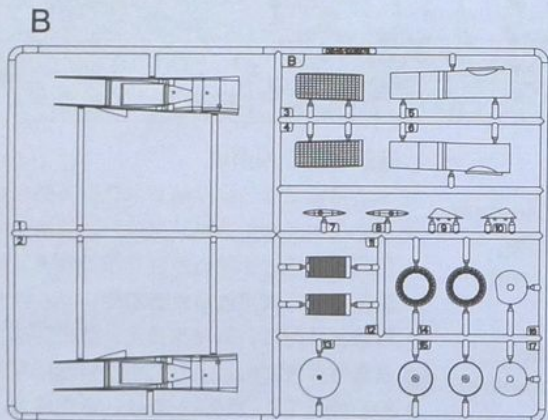
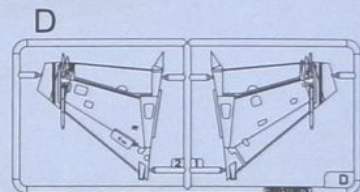
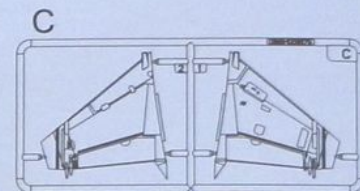
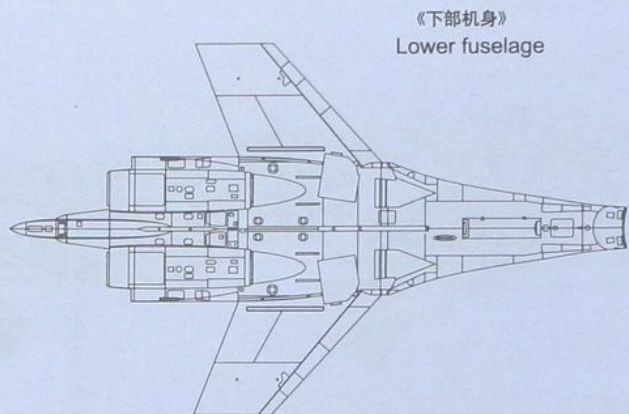
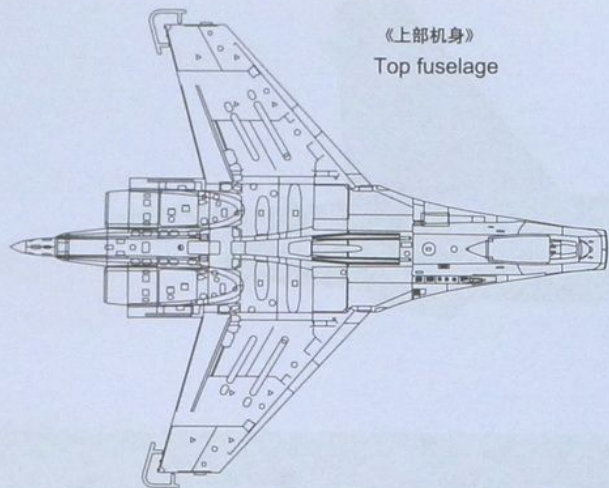

《水貼》 A  
Decal



《水貼》 B  
Decal



《水貼》 C  
Decal

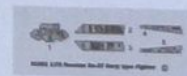

《水貼》 D  
Decal



不用部件: A9 A13 A32 A37 A39 GP4 N7 N8  
Unused parts

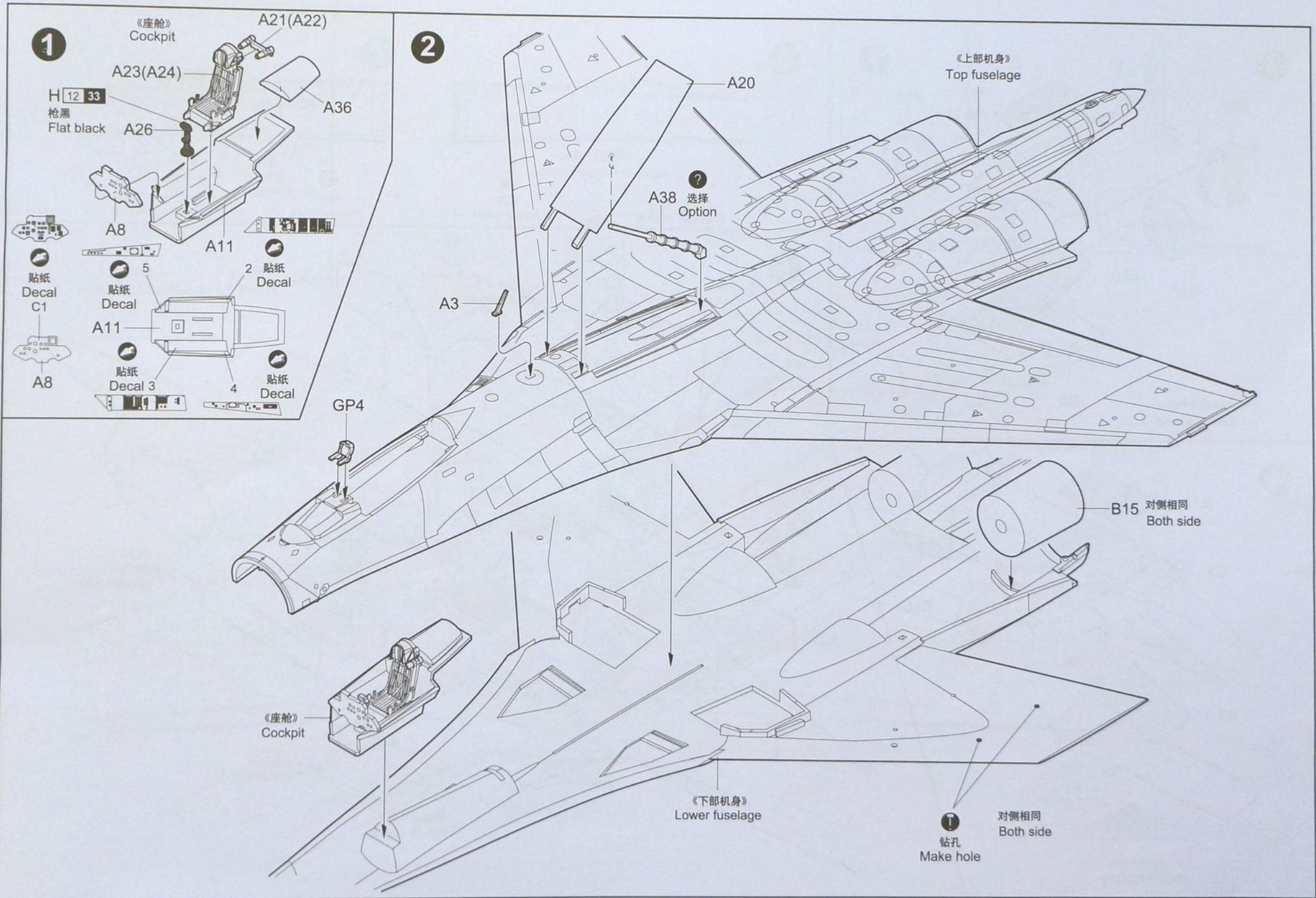

3

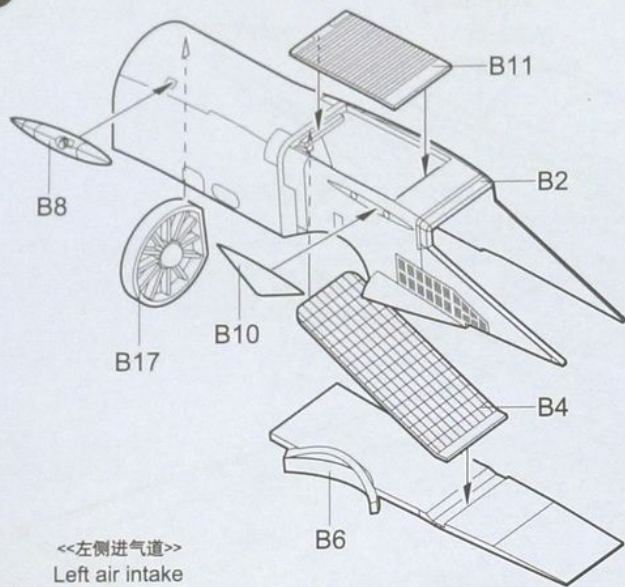

4

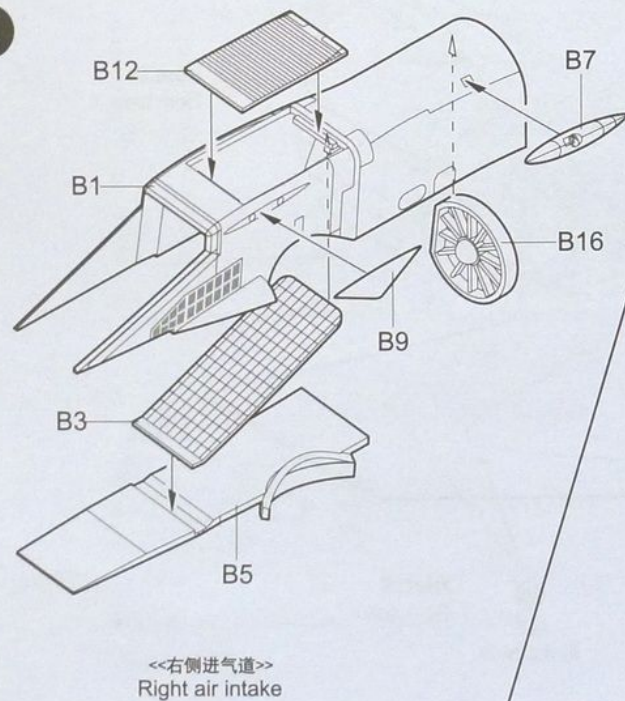

5

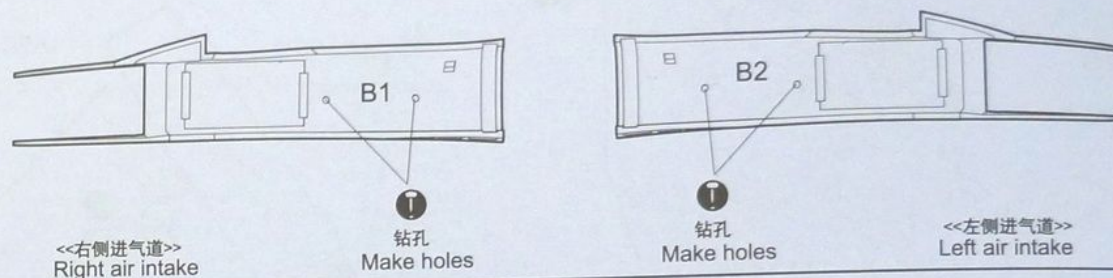

6

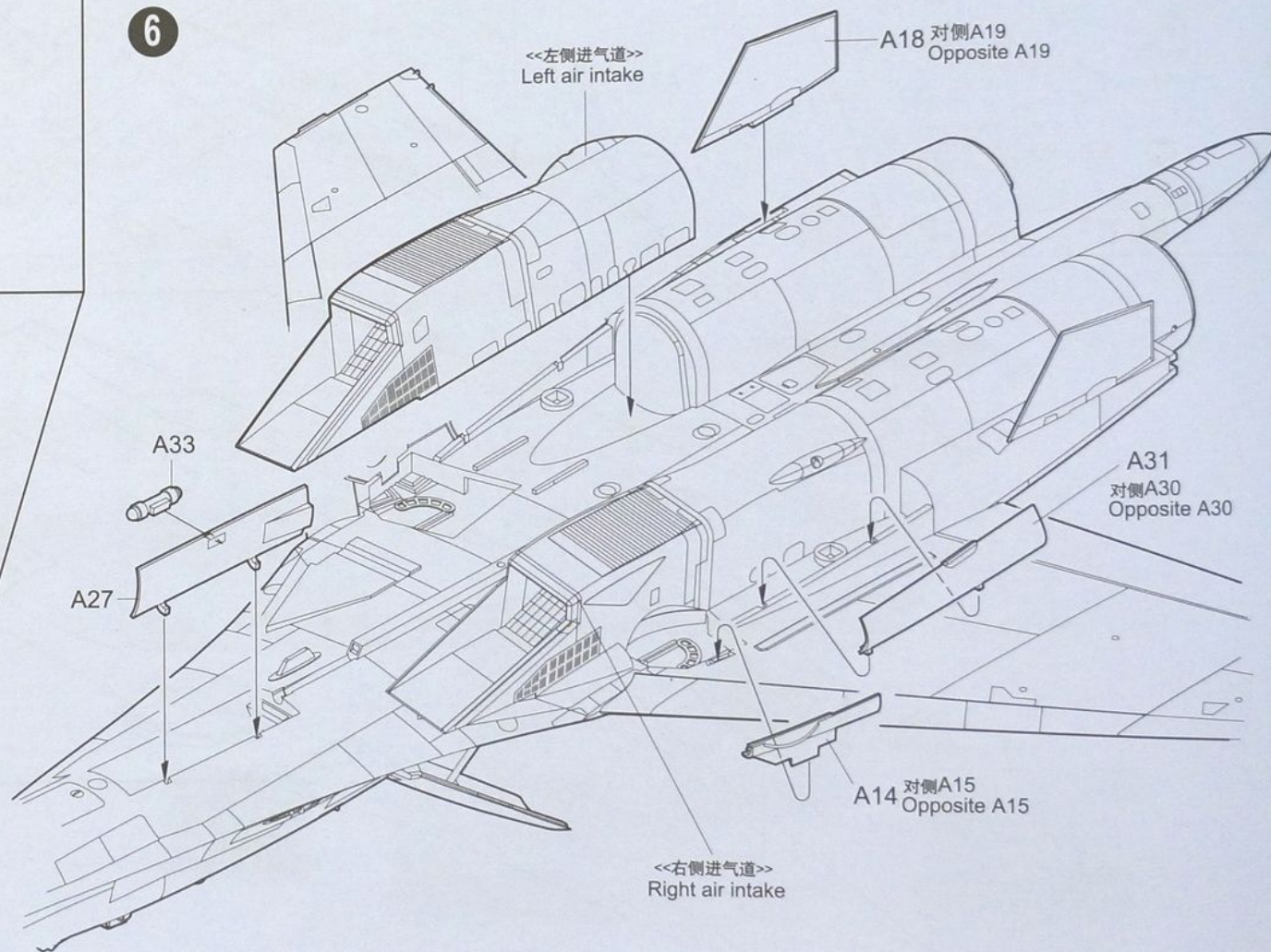

7

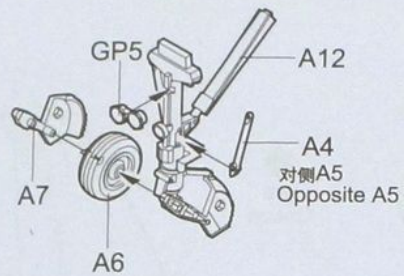

<<前起落架>>  
Nose undercarriage

9

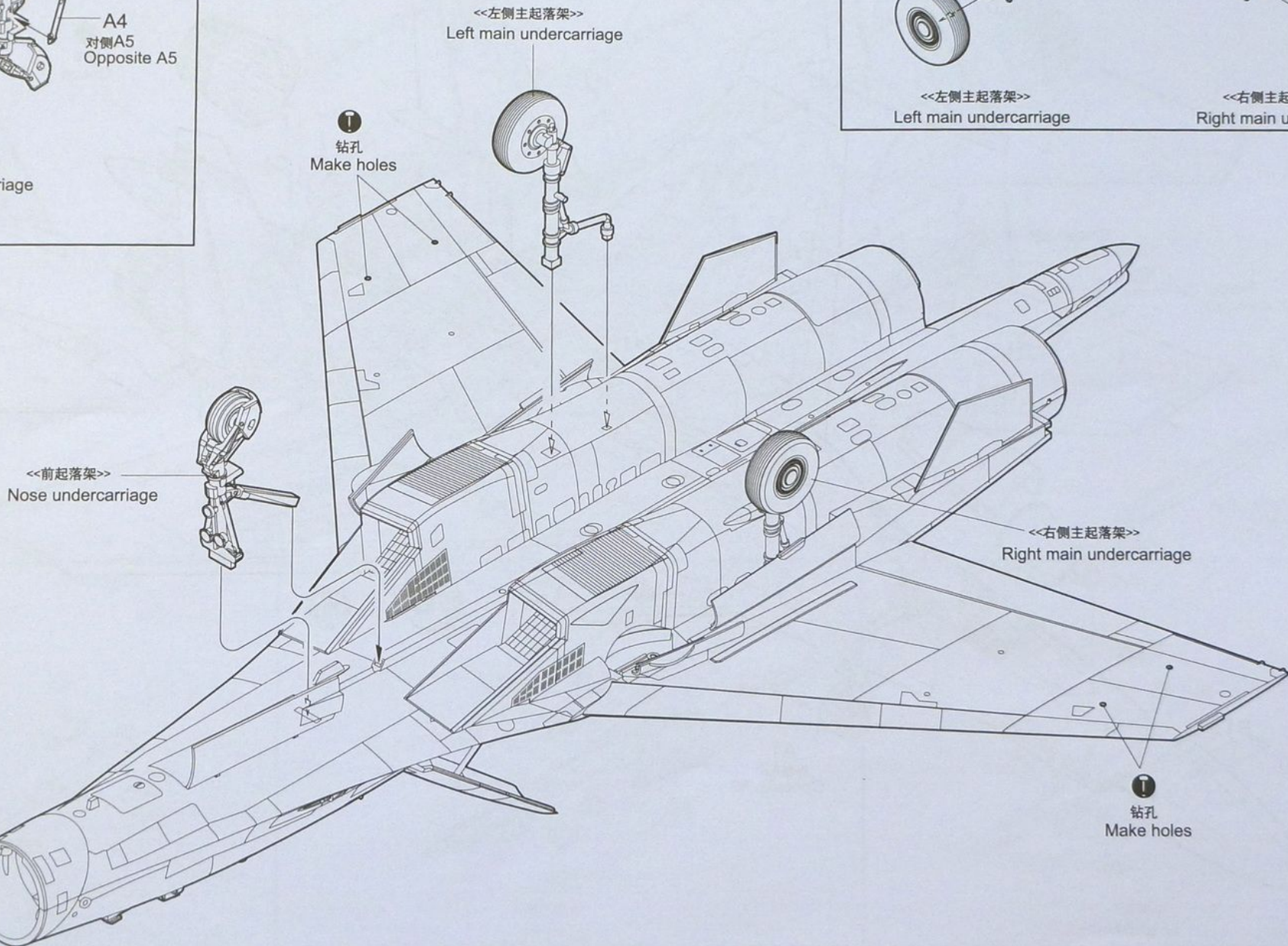

<<前起落架>>  
Nose undercarriage

<<左侧主起落架>>  
Left main undercarriage

<<右侧主起落架>>  
Right main undercarriage

T  
钻孔  
Make holes

T  
钻孔  
Make holes

8

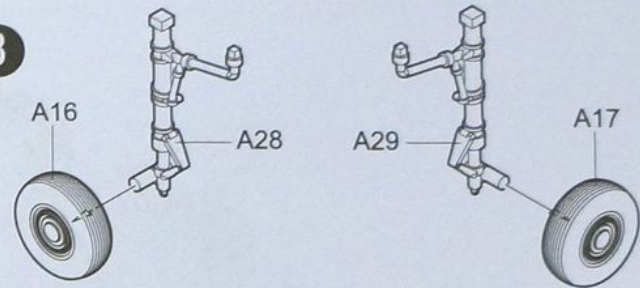

<<左侧主起落架>>  
Left main undercarriage

<<右侧主起落架>>  
Right main undercarriage

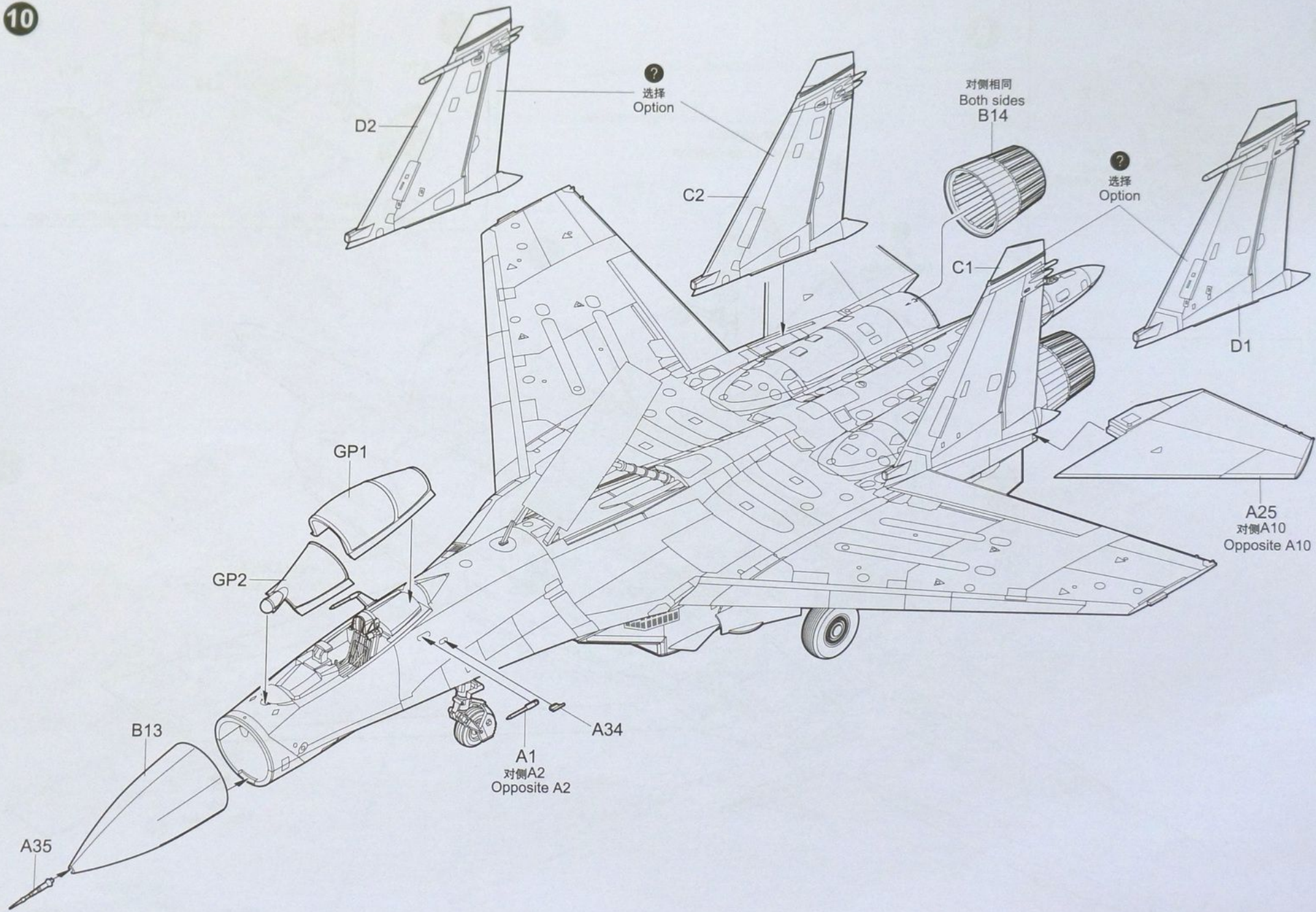

11

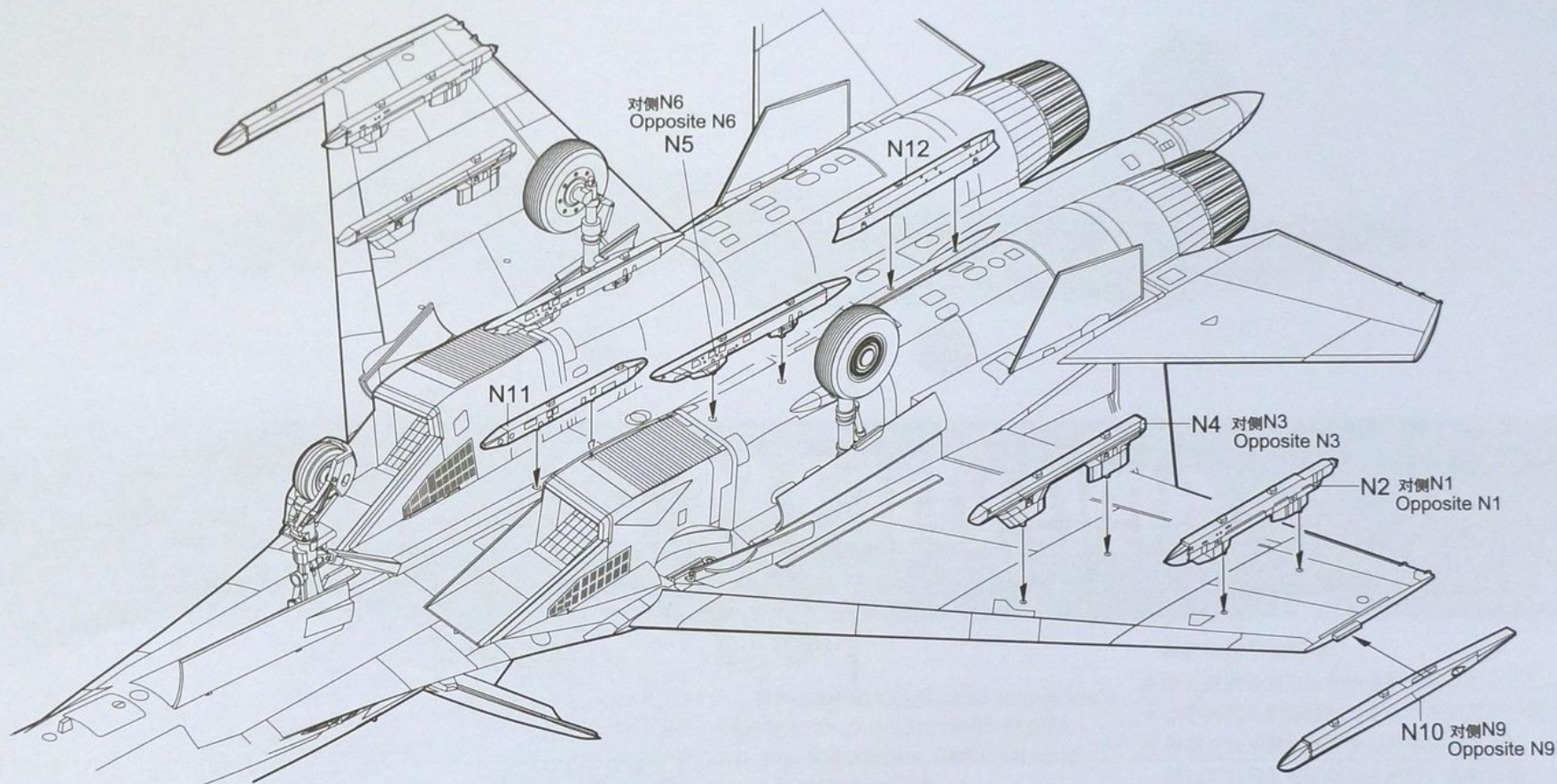

12

<<R-73E>>

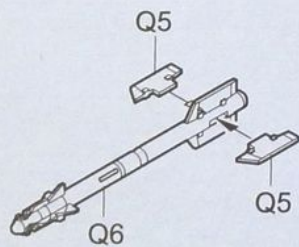

制作6组  
Make six

13

<<R-27T>>

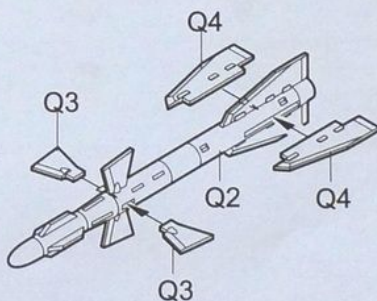

制作6组  
Make six

14

<<R-27R>>

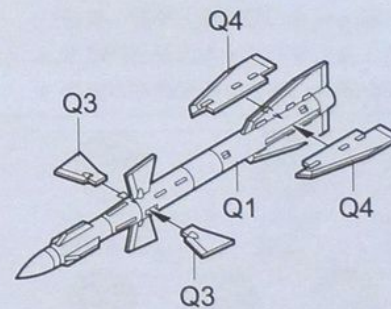

制作6组  
Make six

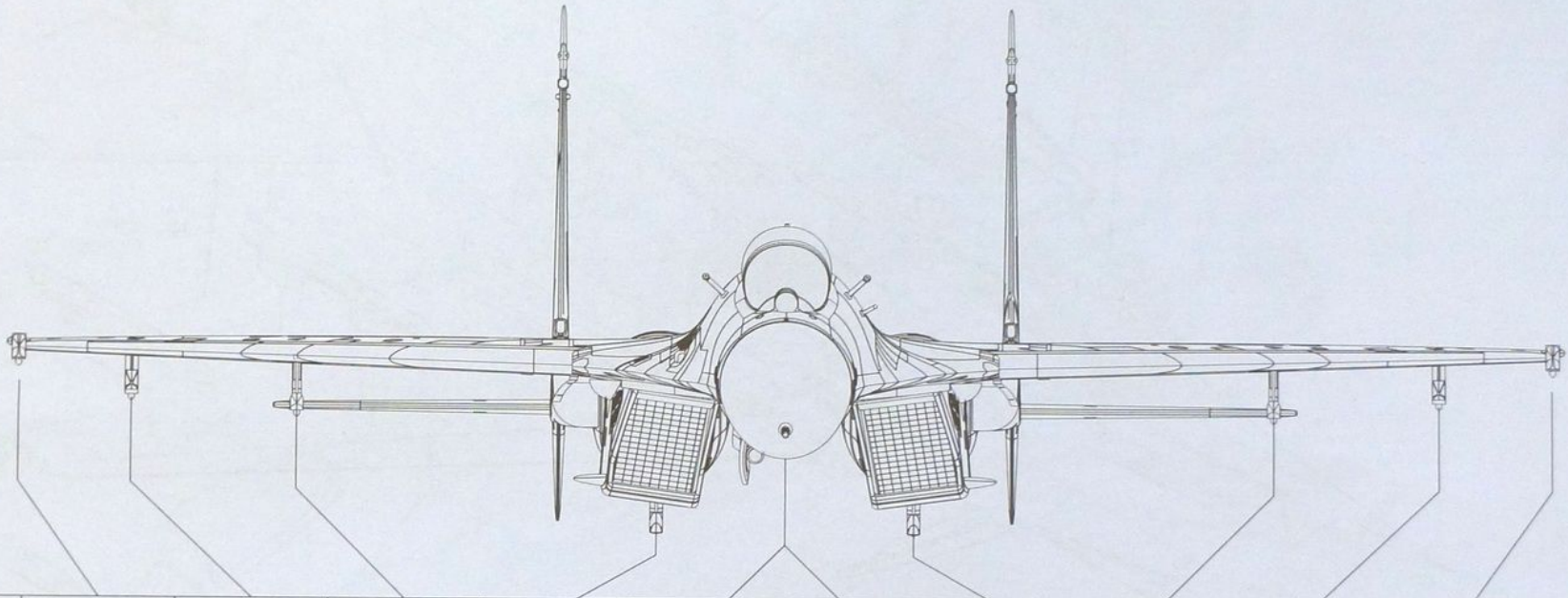

Missile \ Sta.No.	1	2	3	4	Front	back	5	6	7	8
R-73E	●	●							●	●
R-27T			●	●	●	●	●	●		
R-27R			●	●	●	●	●	●		



# 涂装同标贴指示 Painting & Marking guide

**A**

## PAINT REFERENCE COLOUR

Color	Mr.Hobby	Vallejo	Model Master	Tamiya	Humbrol
红色 Red	H 3 3	908	1503	X7	19
银色 Silver	H 8 8	997	1546	X11	11
烧铁色 Burnt Iron	H 76 61	863	1795	X10	53
胎黑色 Tire black	H 77 137	-	-	-	-
透明红 Clear Red	H 90 47	934	-	X27	-
透明绿 Clear Green	H 94 138	936	-	X25	-

## PAINT REFERENCE COLOUR

Color	Mr.Hobby	Vallejo	Model Master	Tamiya	Humbrol
黑棕色 Metal Brown	H 18 28	864	1402	-	-
灰白色 Aircraft Gray	H 57 73	-	-	-	-
灰蓝色 Intermediate Blue	H 56 72	903	1720	-	144
珍珠灰 Pearl Gray	H 74	-	-	-	-
白色 White insignia	H 319 319	991	1745	X2	22
薄绿色 Light Green	H 319 319	-	1713	-	117



H X AQUEOUS HOBBY COLOR

Mr. COLOR

# 涂装同标贴指示 Painting & Marking guide

**B**

PAINT REFERENCE COLOUR						PAINT REFERENCE COLOUR					
Color	Mr.Hobby	Vallejo	Model Master	Tamiya	Humbrol	Color	Mr.Hobby	Vallejo	Model Master	Tamiya	Humbrol
红色 Red	H 3 3	906	1503	X7	19	黑棕色 Metal Brown	H 18 28	864	1402	-	-
银色 Silver	H 8 8	997	1546	X11	11	灰白色 Aircraft Gray	H 57 73	-	-	-	-
烧蚀色 Burnt Iron	H 76 61	863	1795	X10	53	灰蓝色 Intermediate Blue	H 56 72	903	1720	-	144
胎黑色 Tire black	H 77 137	-	-	-	-	浅灰蓝色 Pearl Grey	H 74	-	-	-	-
透明红 Clear Red	H 90 47	934	-	X27	-	白色 White Insignia	H 319 319	991	1745	X2	22
透明绿 Clear Green	H 94 138	936	-	X25	-	浅绿色 Light Green	H 319 319	-	1713	-	117



H [ ] AQUEOUS HOBBY COLOR    [ ] Mr. COLOR

# 涂装同标贴指示 Painting & Marking guide

## PAINT REFERENCE COLOUR

Color	Mr.Hobby	Vallejo	Model Master	Tamiya	Humbrol	Color	Mr.Hobby	Vallejo	Model Master	Tamiya	Humbrol
White 白色	H 1 1	842	1745	XF2	22	Smoke Blue 烟蓝色	H 95 101	-	-	-	-
Burnt Iron 烧铁色	H 76 61	863	1795	XF10	53	White 白色	H 318 316	991	1745	X2	22
Gray 灰色	H 308 308	990	1728	XF19	127	Intermediate Blue 灰蓝色	H 56 72	903	1720	-	144

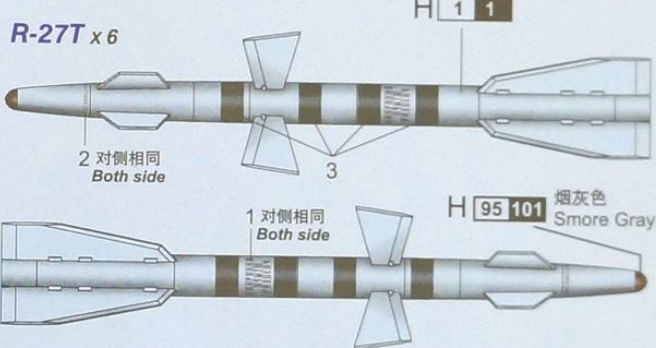
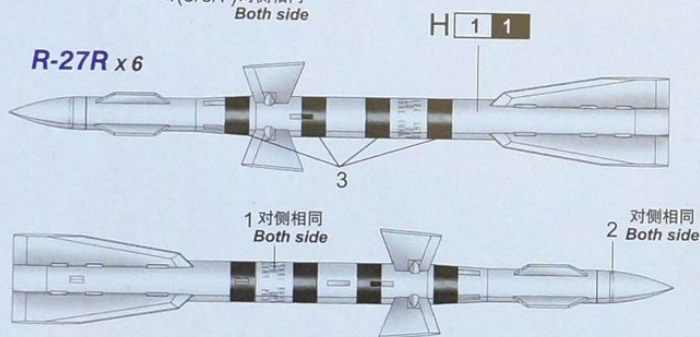
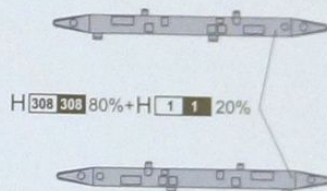
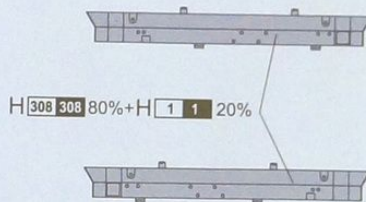
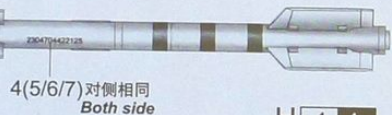
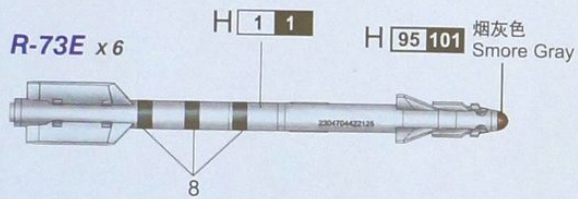

### Wingtip missile launch rail X 2

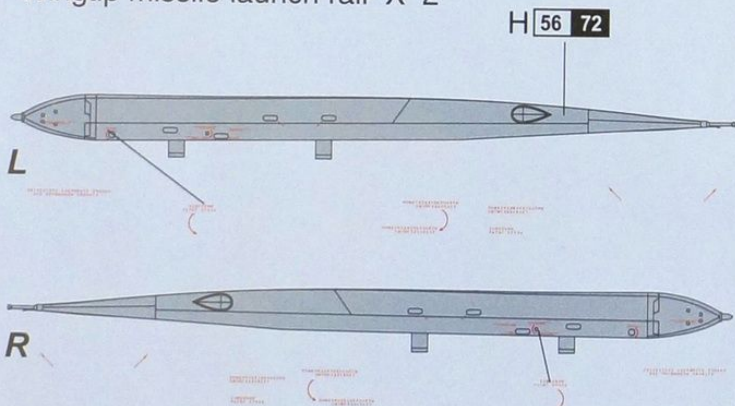

### Inside-wing missile launch rail X 2

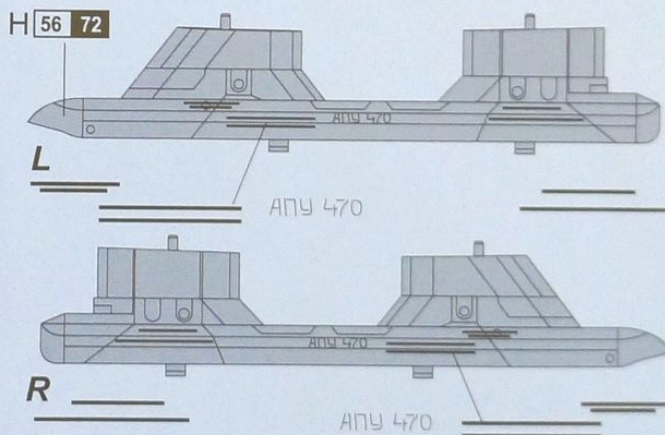

### Outer-wing missile launch rail X 2

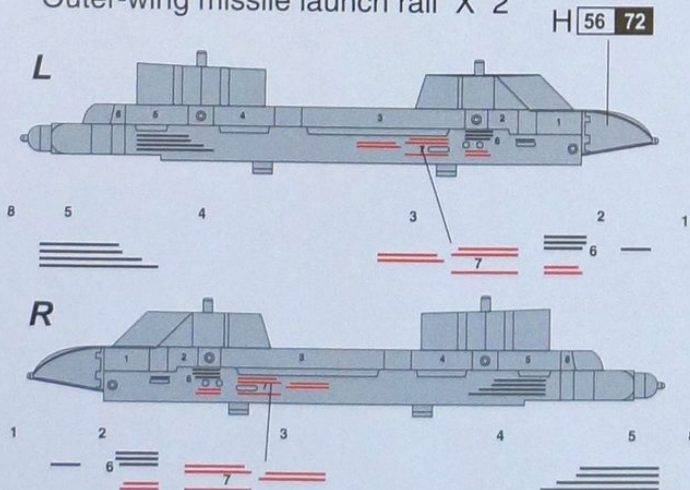

### Intake-mounted missile launch rail X 2

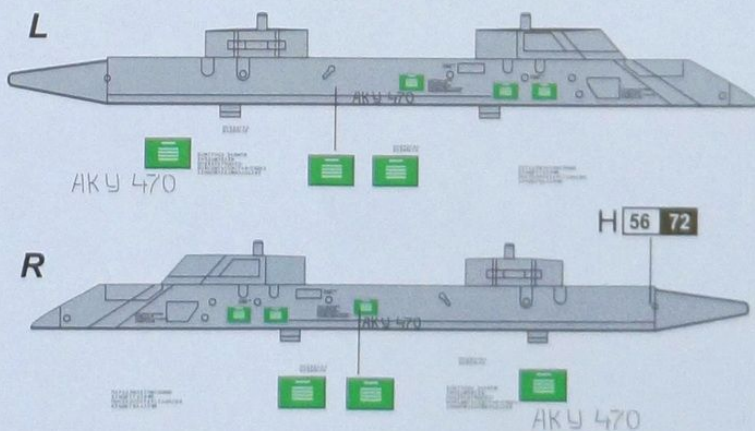

H X AQUEOUS HOBBY COLOUR

X MR.COLOUR