

U-2

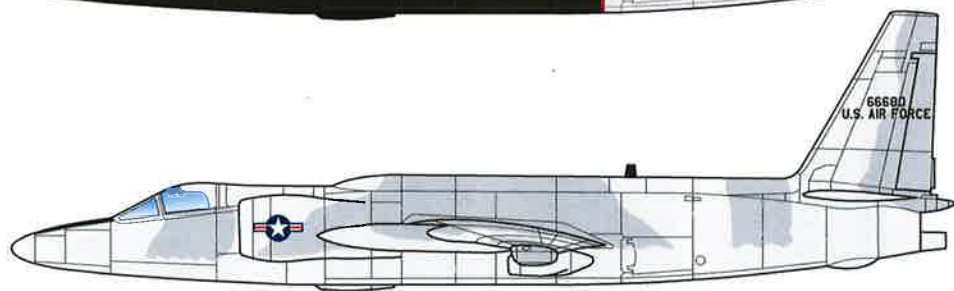
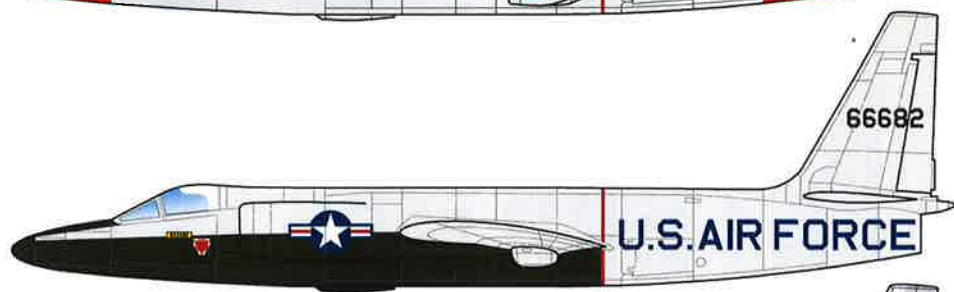
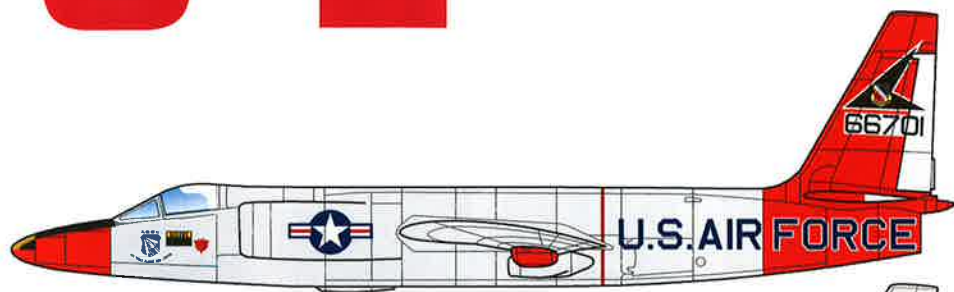

**TEN MARKING OPTIONS
FOR EARLY U-2 SPYPLANES
DESIGNED FOR THE HAWK/TESTORS KIT**

1/48 SCALE

DECALS PRINTED BY



OPTION 1: U-2A 56-6701

AIR FORCE FLIGHT TEST CENTER, EDWARDS AFB

EARLY 1960S

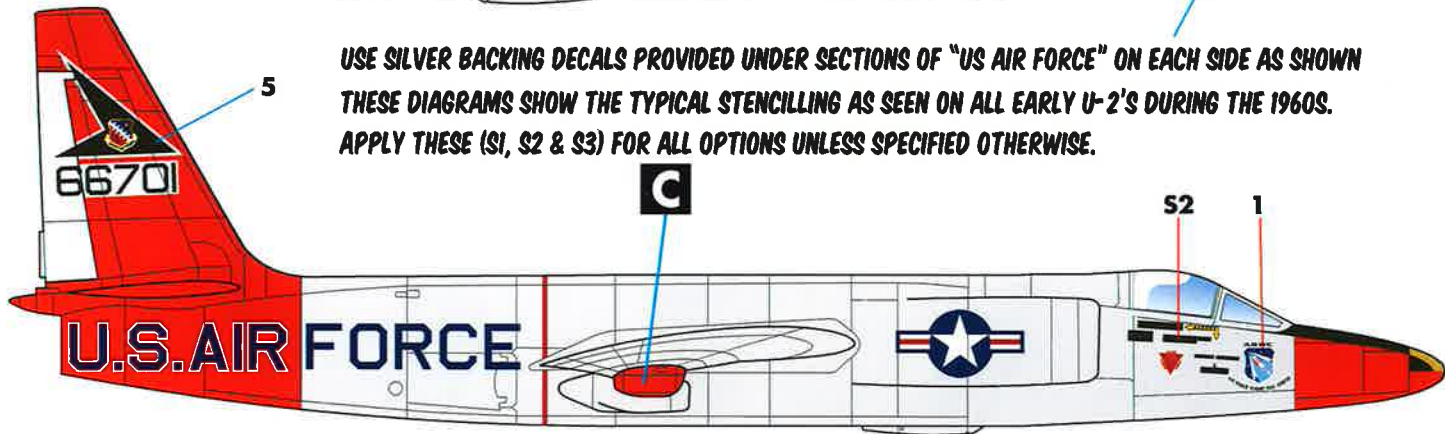
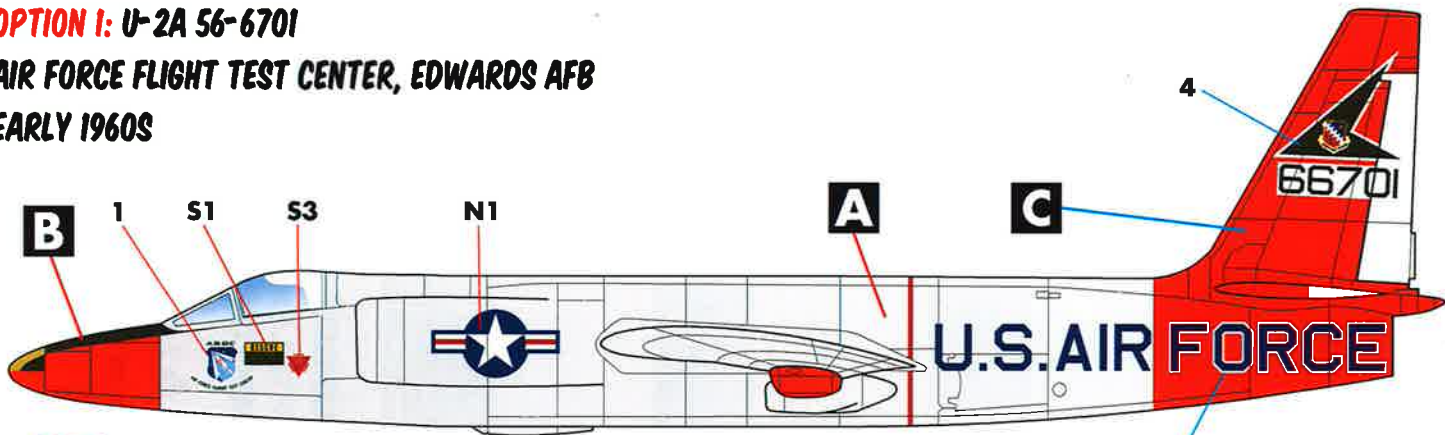

**USE SILVER BACKING DECALS PROVIDED UNDER SECTIONS OF "US AIR FORCE" ON EACH SIDE AS SHOWN
THESE DIAGRAMS SHOW THE TYPICAL STENCILLING AS SEEN ON ALL EARLY U-2'S DURING THE 1960S.
APPLY THESE (S1, S2 & S3) FOR ALL OPTIONS UNLESS SPECIFIED OTHERWISE.**

OPTION 2: U-2A 56-6715

4080TH SRW

1960

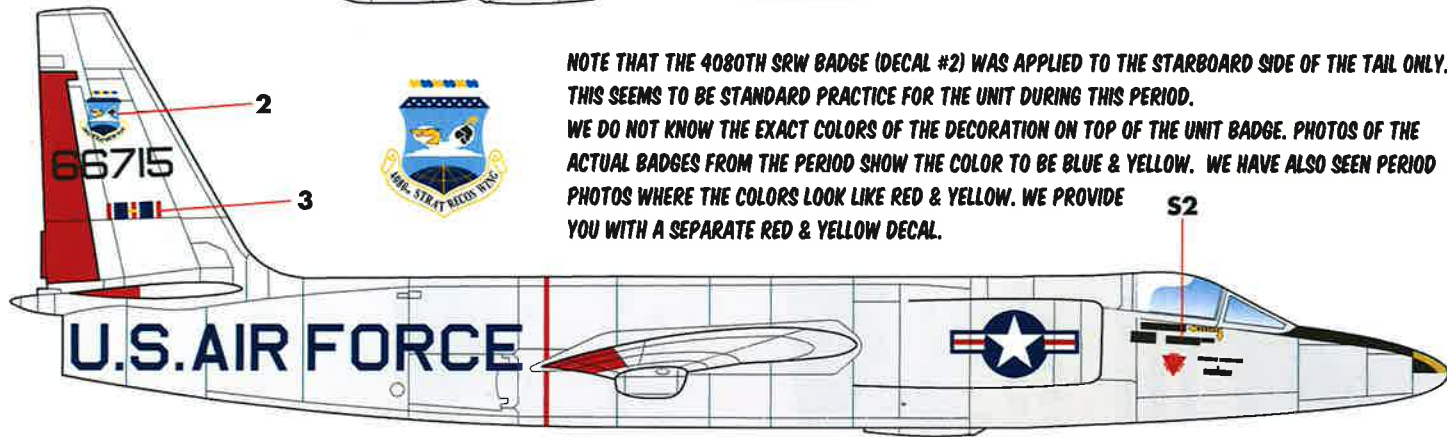
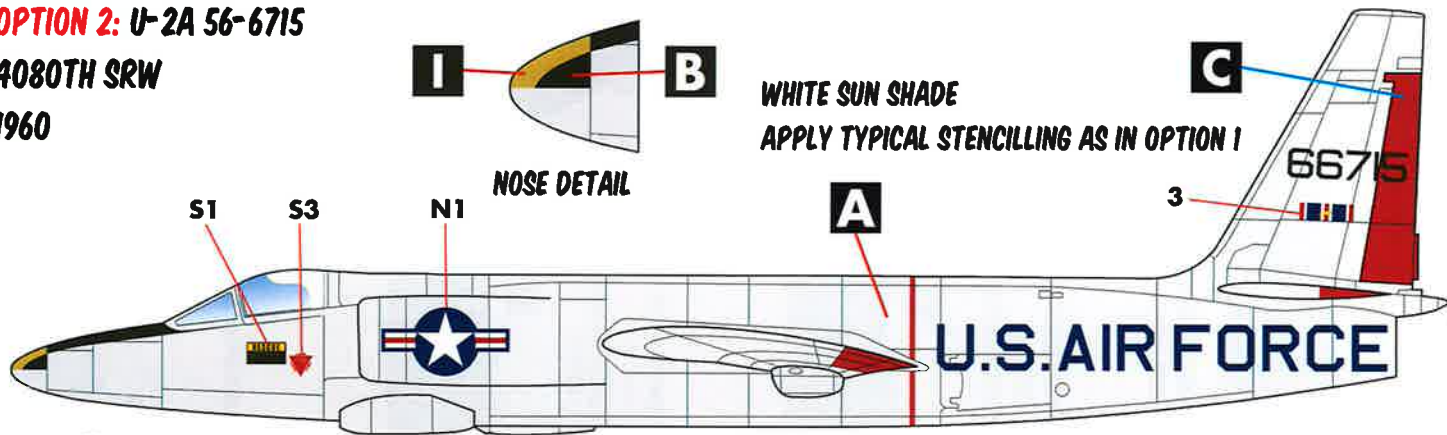

NOTE THAT THE 4080TH SRW BADGE (DECAL #2) WAS APPLIED TO THE STARBOARD SIDE OF THE TAIL ONLY. THIS SEEMS TO BE STANDARD PRACTICE FOR THE UNIT DURING THIS PERIOD. WE DO NOT KNOW THE EXACT COLORS OF THE DECORATION ON TOP OF THE UNIT BADGE. PHOTOS OF THE ACTUAL BADGES FROM THE PERIOD SHOW THE COLOR TO BE BLUE & YELLOW. WE HAVE ALSO SEEN PERIOD PHOTOS WHERE THE COLORS LOOK LIKE RED & YELLOW. WE PROVIDE YOU WITH A SEPARATE RED & YELLOW DECAL.



OPTION 3: U-2A 56-6703
4080TH SRW
1961

WHITE SUN SHADE
APPLY TYPICAL STENCILLING AS IN OPTION 1

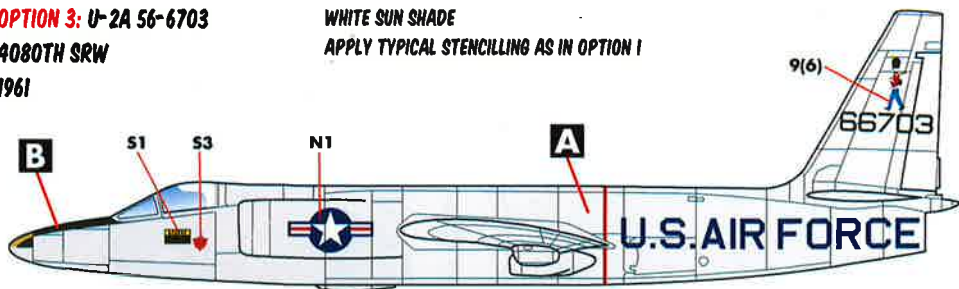

THE ARTWORK ON THE TAIL WAS MOST LIKELY APPLIED FOR THE "TOY SOLDIER" AIR SAMPLING DEPLOYMENT TO ALASKA DURING 1961. WE HAVE ONLY SEEN PHOTOS SHOWING IT APPLIED ON THE STARBOARD SIDE. WE BELIEVE IT WAS PROBABLY APPLIED TO BOTH SIDES.

OPTION 4: U-2A "N800X"
CENTRAL INTELLIGENCE AGENCY (CIA)
EARLY 1960S

LONG "CANOE" FAIRING ON TOP OF THE FUSELAGE
WHITE SUN SHADE
APPLY TYPICAL STENCILLING AS IN OPTION 1



OPTION 5: U-2A "N803X"
CENTRAL INTELLIGENCE AGENCY (CIA)
EARLY 1960S

SHORT "CANOE" FAIRING ON TOP OF THE FUSELAGE
WHITE SUN SHADE
APPLY TYPICAL STENCILLING AS IN OPTION 1



OPTION 6: U-2A 56-6682
4080TH SRW
1961

WHITE SUN SHADE
APPLY TYPICAL STENCILLING AS IN OPTION 1

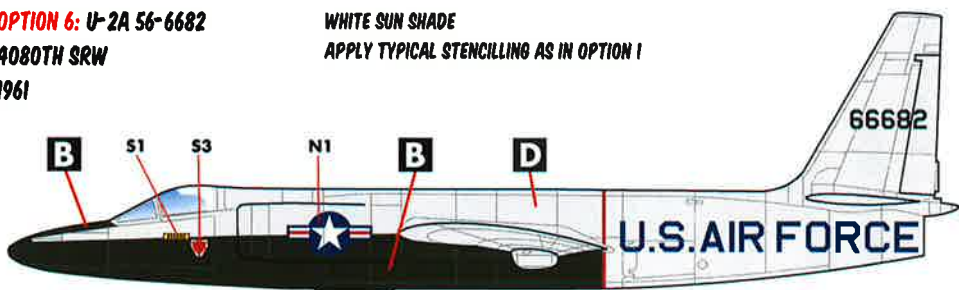

OPTION 7: U-2F 56-6676
MAJ. RUDOLF ANDERSON'S AIRPLANE
1962

SHORT "CANOE" FAIRING ON TOP OF THE FUSELAGE
 WHITE SUN SHADE
 APPLY TYPICAL STENCILLING AS IN OPTION 1

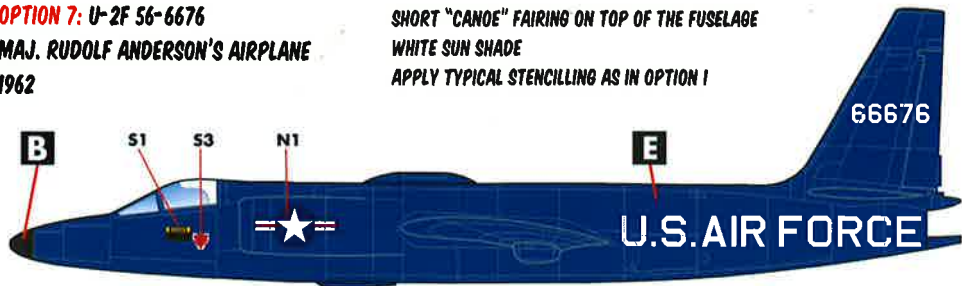

THIS DRAWING REFLECTS OUR BEST GUESS OF HOW MAJ. ANDERSON'S AIRPLANE LOOKED LIKE, BASED ON OUR ANALYSIS OF PHOTOS OF THE WRECKAGE. THIS PARTICULAR AIRPLANE SEEMS TO BE AN OVERALL SEA BLUE FORMER CIA AIRCRAFT

OPTION 8: U-2A 56-6681
4080TH SRW

SHORT "CANOE" FAIRING ON TOP OF THE FUSELAGE
 WHITE SUN SHADE
 APPLY TYPICAL STENCILLING AS IN OPTION 1
4080TH SRW BADGE ON STARBOARD SIDE OF TAIL (SEE OPT.2)

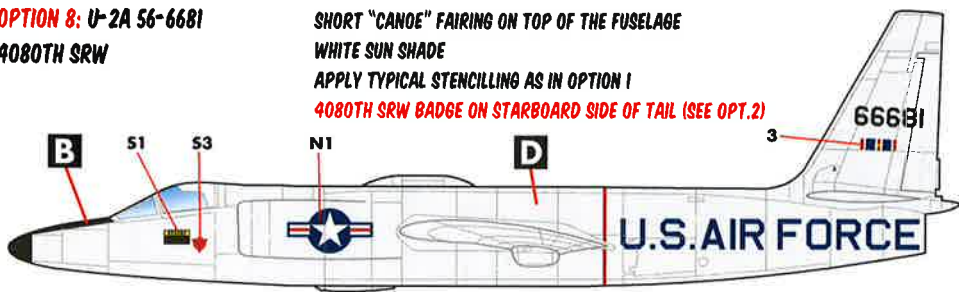

OPTION 9: U-2C 56-6680
100TH SRW
1976

U-2C FULL SPINE FAIRING ON TOP OF THE FUSELAGE
 "COKE BOTTLE" ENLARGED INTAKES, SLIPPER TANKS
 SUN SHADE PAINTED IN LIGHTER CAMOUFLAGE COLOR
 NO VISIBLE STENCILLING

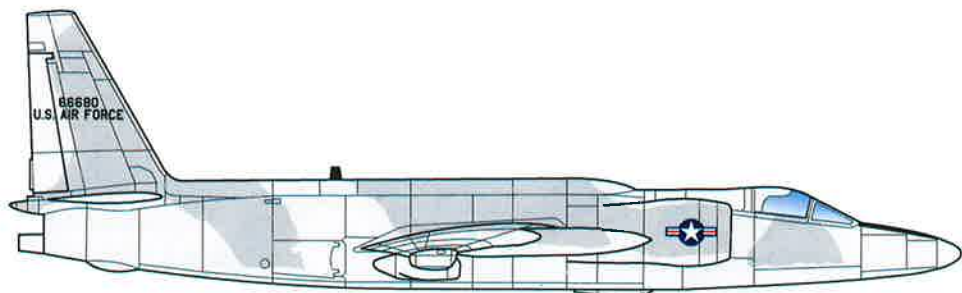
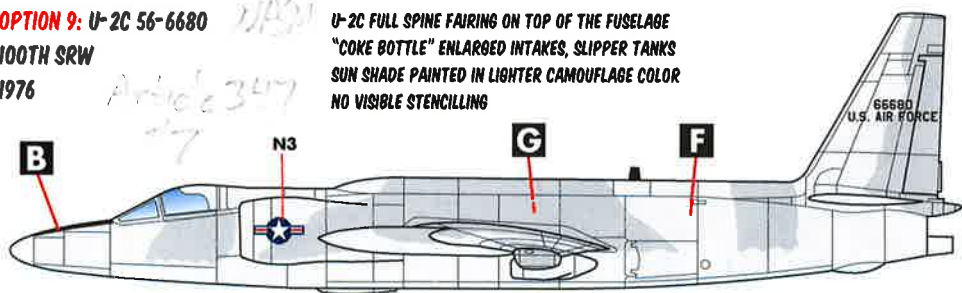

OPTION 9: U-2A 56-6722

PROJECT "HI-CAT"

RAE BEDFORD

1967

SHORT "CANOE" FAIRING ON TOP OF THE FUSELAGE
WHITE SUN SHADE
APPLY TYPICAL STENCILLING AS IN OPTION 1
KANGAROO "ZAP" ON TAIL LIKELY APPLIED TO BOTH SIDES
RED STRIPING ON PROBE

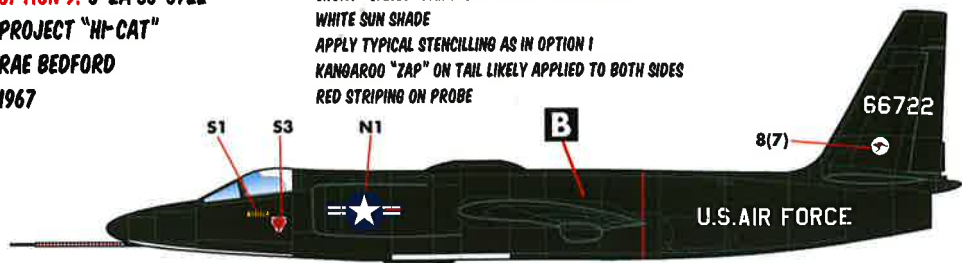

NOTE THE USE OF WHITE "US AIR FORCE" IN MODERN 45-DEGREE STYLE

PLACEMENT OF WING MARKINGS

WE HIGHLY RECOMMEND DOWNLOADING AND PRINTING THE 1/48 SCALE PLACEMENT GUIDES WE HAVE PREPARED AND MADE AVAILABLE AT THE REFERENCE WEB SITE. THESE ARE DESIGNED TO MATCH YOUR TESTORS/HAWK KIT PRECISELY. THEY ARE AVAILABLE AT:

[HTTP://WWW.CARACALMODELS.COM/REFERENCES/CD48118](http://www.caracalmodels.com/references/cd48118)

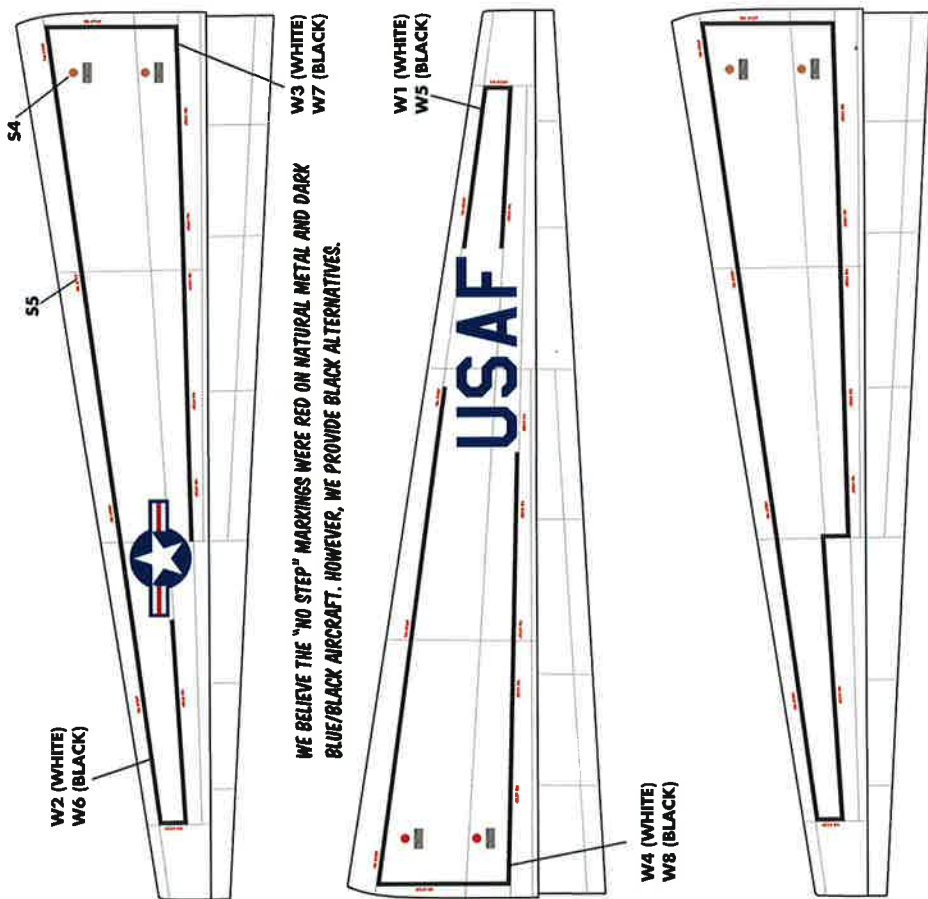

OPTIONS 1-3, 6,7,8,10

OPTIONS 4 & 5 (LEFT SHOWN)

THE WING DRAWINGS ON THIS PAGE ARE 1/96 SCALE.

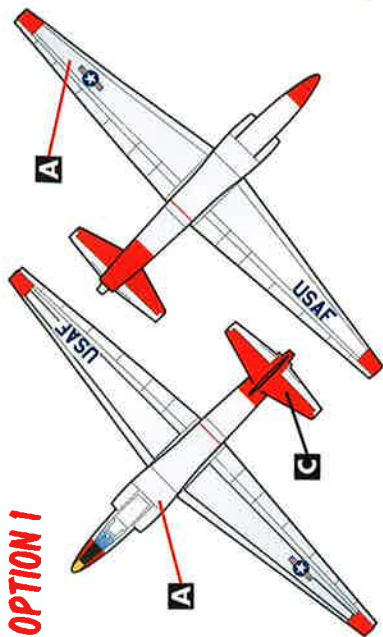

OPTION 1

BLACK WING WALKWAYS, INSIGNIA BLUE "USAF"

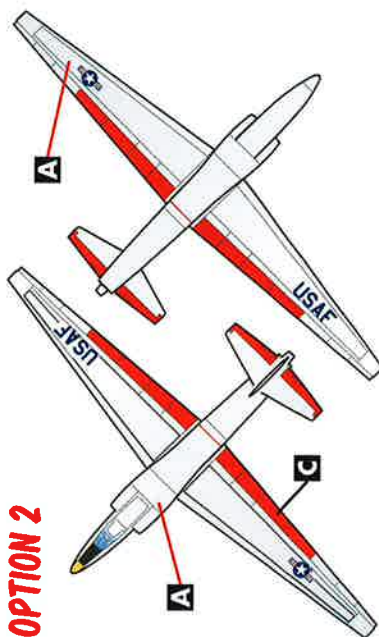

OPTION 2

BLACK WING WALKWAYS, INSIGNIA BLUE "USAF"

LARGER VERSIONS OF THESE DIAGRAMS ARE AVAILABLE ONLINE AT THE REFERENCE SITE:

[HTTP://WWW.CARACALMODELS.COM/REFERENCES/CD48118](http://www.caracalmodels.com/references/cd48118)

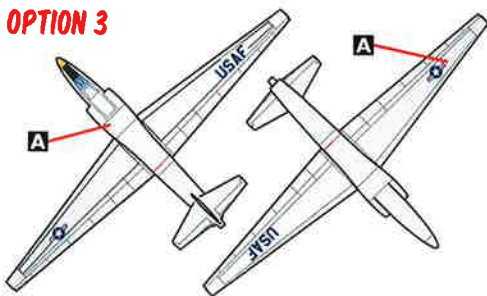

OPTION 3

BLACK WING WALKWAYS, INSIGNIA BLUE "USAF"



OPTIONS 4 & 5

WHITE WING WALKWAYS, NO NATIONAL INSIGNIA OR "USAF"

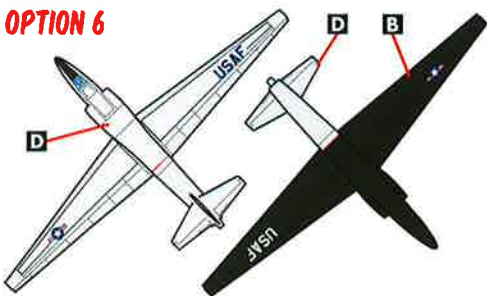

OPTION 6

BLACK WING WALKWAYS, INSIGNIA BLUE "USAF" TOPSIDE, WHITE "USAF" UNDER

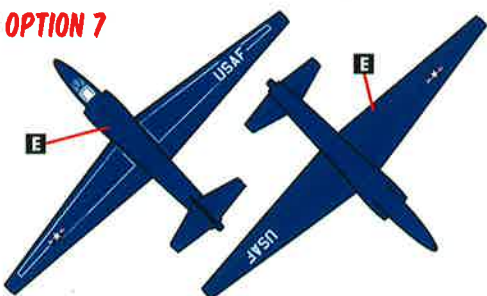

OPTION 7

WHITE WING WALKWAYS, WHITE "USAF"

- A** NATURAL METAL
- B** FLAT BLACK (FS37038)
- C** FLUORESCENT RED (FS28913)
- D** AIRCRAFT GRAY (FS16473)
- E** DARK SEA BLUE (FS15042)
- F** SEMI-GLOSS GULL GRAY (FS26440)
- G** SEMI-GLOSS NEUTRAL GRAY (FS26270)
- H** FLAT WHITE (FS37875)
- I** EARTH YELLOW (FS30257)

OPTION 10

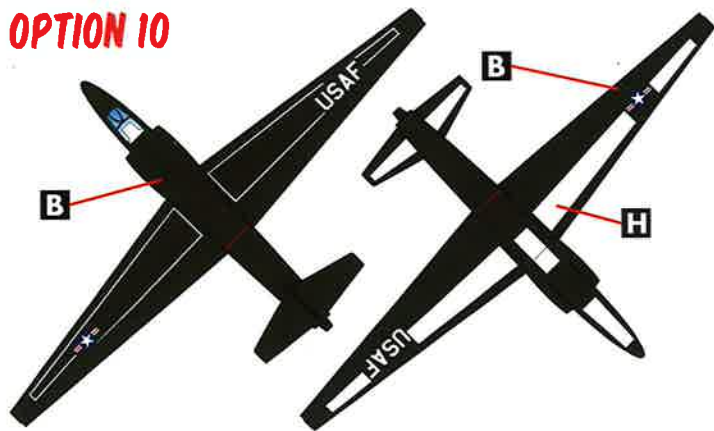

WHITE WING WALKWAYS, WHITE "USAF"

OPTION 8

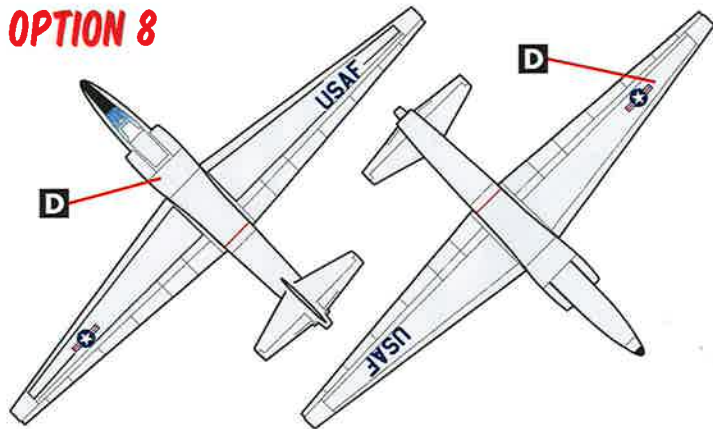

BLACK WING WALKWAYS, INSIGNIA BLUE "USAF"

OPTION 9

