

Read the instructions thoroughly before assembling.

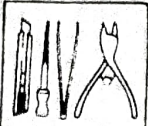

Tools required.



Use a good kit cement. Liquid type cement is recommendable.

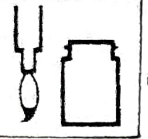

For better finish, paint your model.

— in the sketches means "to cement"
 - - - in the sketches means "not to cement"

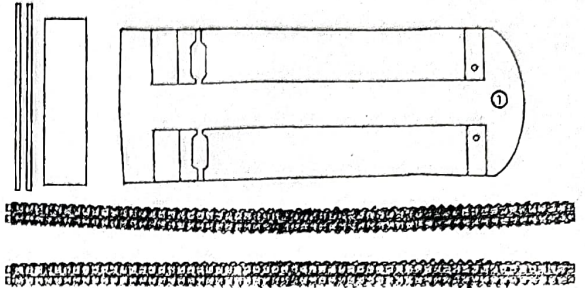
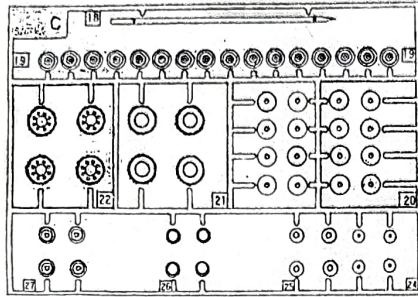
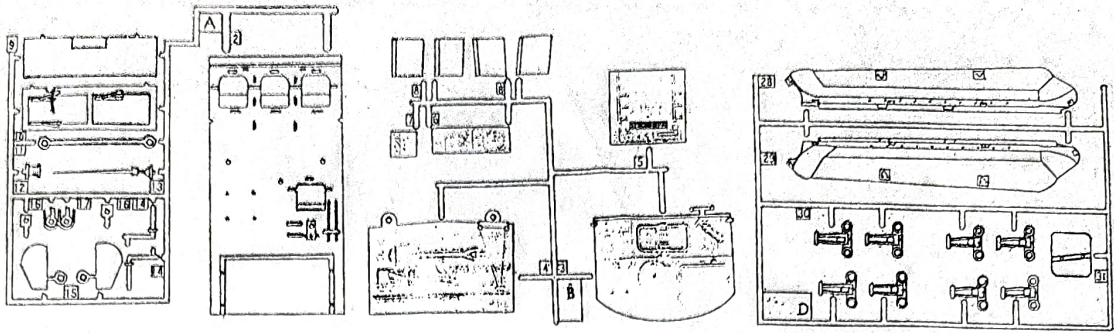

① Middle Wheel Assembly

(8 sets)

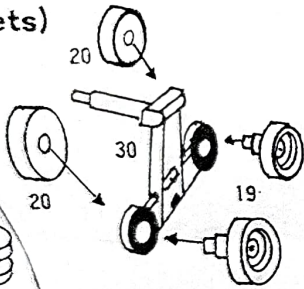

③ Wheels Assembly

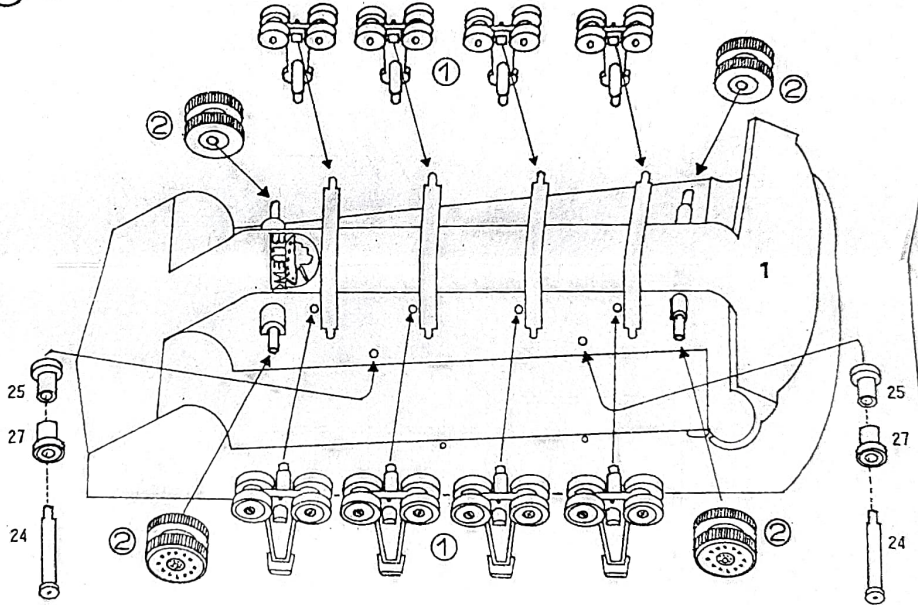

② Wheel Assembly

Drive Wheels (2 sets)

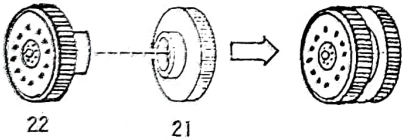

④ Front Parts

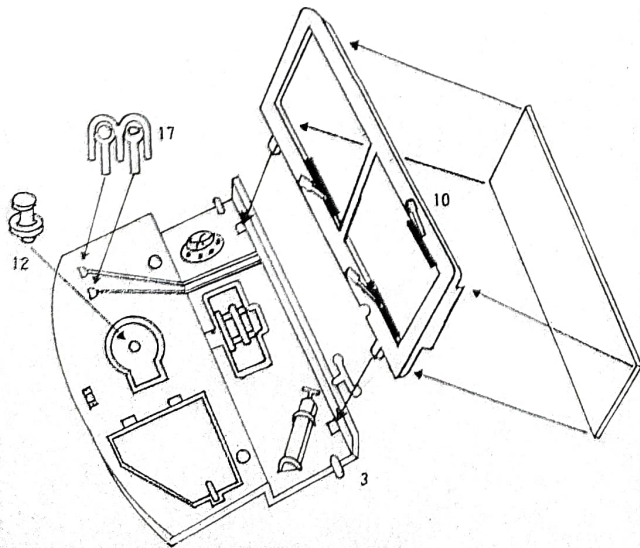

⑤ Roof Assembly

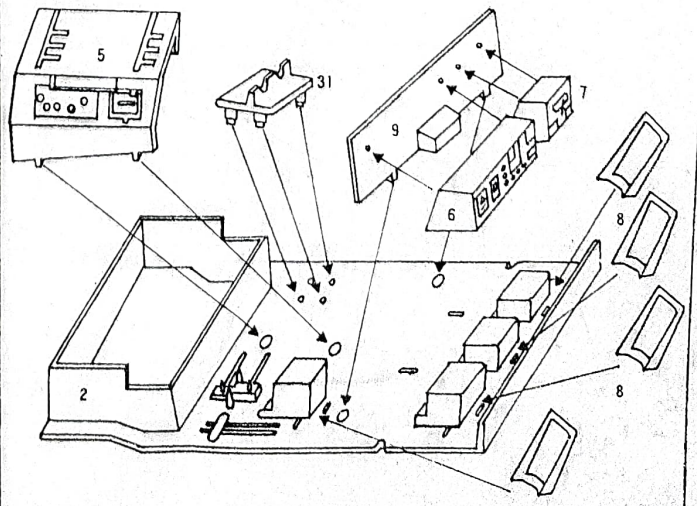

⑥ CARGO AS A WHOLE ASSEMBLY

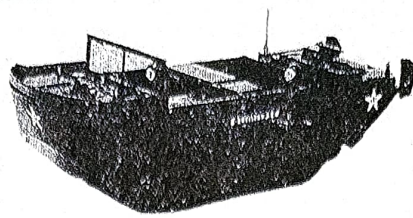

1. Cement ⑤ in place ③ as shown
2. Cement ④ in place ③ as shown
3. Assemble the latter half parts before cementing to ③
4. Put 2 sets of caterpillar which are finished onto wheel
5. Cement 29 to ③ as shown
6. Cement 18 to ③ as shown
7. Figures can be cemented in place as you want

FLOAT STICKER
 Float sticker is assistance the lacking part of paint. This model kit is used high class detailed printing float sticker. Please according to the following procedure to make it:
 1. Cut the need part.
 2. Dip in water 30 second.
 3. Take down by sharp pincers and put to the proper place.

Figures

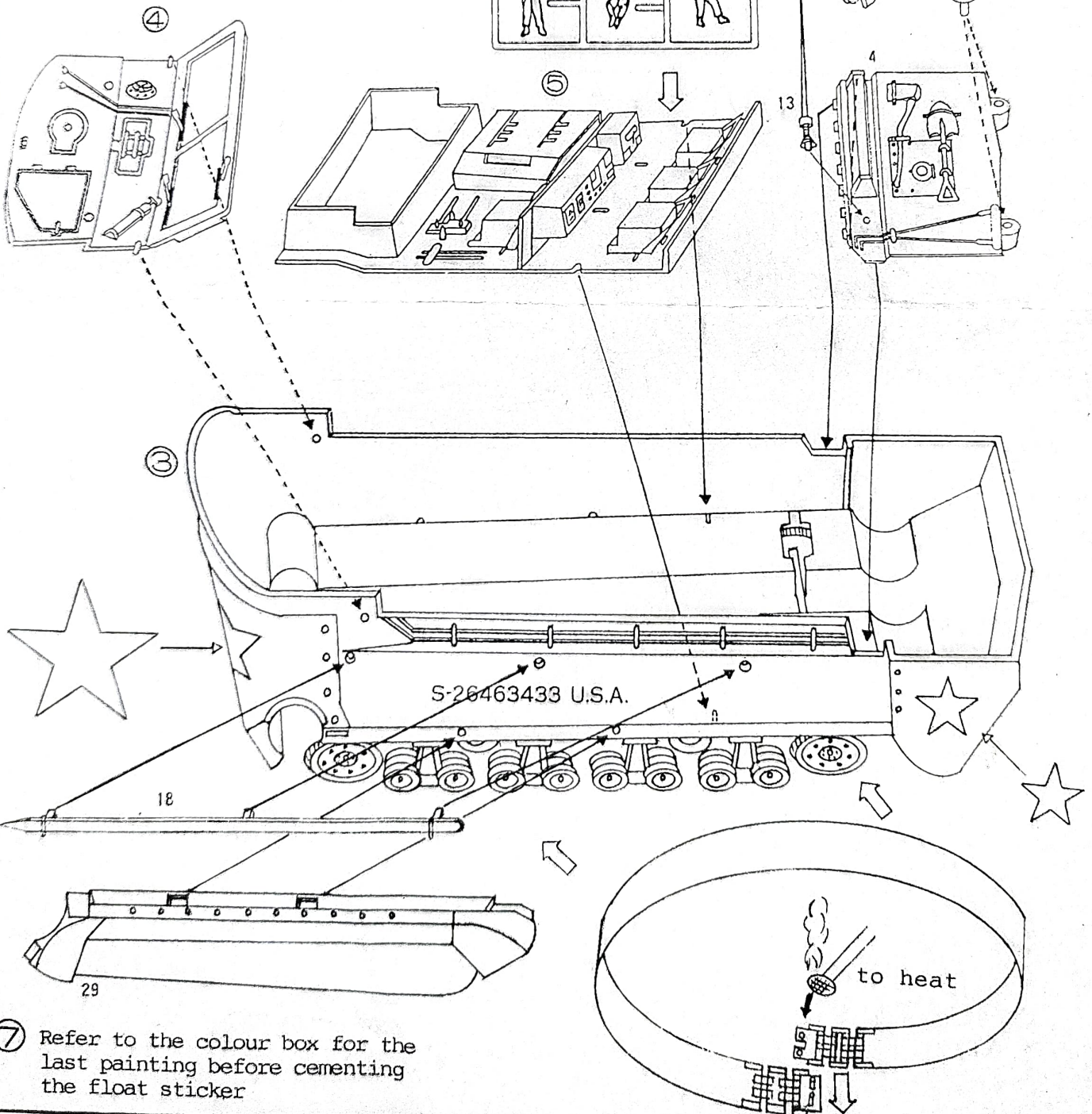
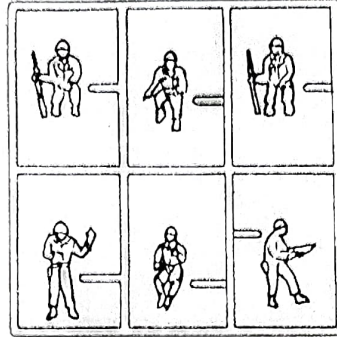

⑦ Refer to the colour box for the last painting before cementing the float sticker