

1/32

Aichi D3A1 Val

1/32 AIRCRAFT SERIES NO.06 — FUSELAGE LENGTH 319 MM

Úvod

Aichi D3A Type 99 (spojenecký název „Val“) byl hlavním typem střemhlavého bombardéru japonského císařského námořního letectva ve II světové válce. „Val“ byl první japonské letadlo, které ve válce bombardovalo americké cíle, počínaje Pearl Harborem a americkými základnami na Filipínách. Na počátku války vzletl z palub letadlových lodí, později z pozemních základů a účastnil se bojů v Korálovém moři, v bitvě u Midway, či v bojích o Salomounovy ostrovy. Tato letadla potopila více spojeneckých válečných lodí než kterékoli jiné letadlo Osy. Vývoj D3A byl zahájen roku 1936 a od roku 1937 do roku 1945 bylo vyrobeno 1495 bombardérů v několika produkčních variantách.

Introduction

The Aichi D3A Type 99 (Allied name „Val“) is a World War II carrier dive bomber. It was the main dive bomber of the IJN and was involved in almost all IJN actions, including the attack on Pearl Harbor. „Val“ was the first Japanese aircraft to bomb American targets in the war, commencing with Pearl Harbor and U.S. bases in the Philippines. They sank more Allied warships than any other Axis aircraft. Development of „Val“ was from 1936 to 1939, 1495 bombers was manufactured.

Doporučujeme / We recommend

Additional sets for D3A1 Val kit:

- › INF3206 1+ Photoetched detail set
- › INF3206 2+ Weapon set (bombs)
- › INF3206 3+ Exhausts set
- › INF3206 4+ Engine set
- › INF3206 5+ Wing tip's navigation lights
- › INF3206 6+ Type 92 machine gun
- › INF3206 7+ Folded wings



Ohnout
Bend



Vrtat
Drill



Volba
Option



Upravit
File



Vyrobít
Scratch build



Vteřinové lepidlo
Cyanoacrylate glue



Odstranit
Remove



Obtisk
Decal



Barva
Colour



Tmelit
Fill



Průhledná folie
Transparent foil



Symetrická montáž
Symmetrical assembly

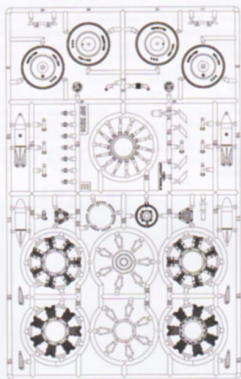
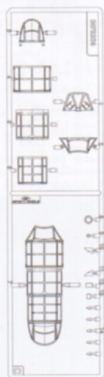
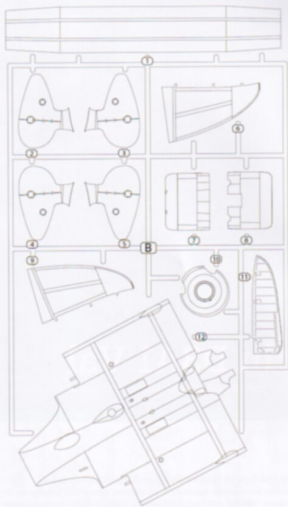
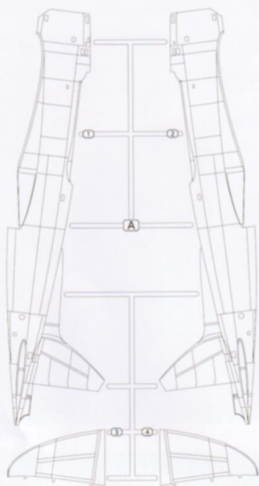

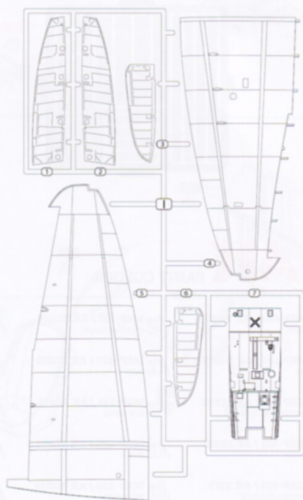
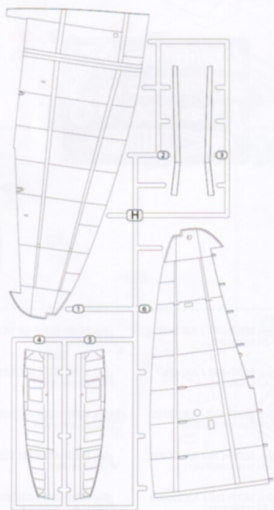
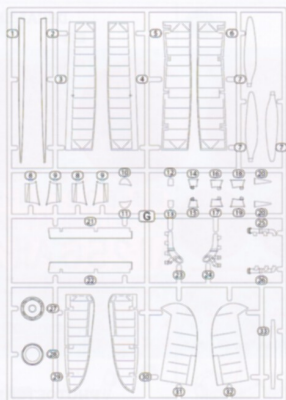
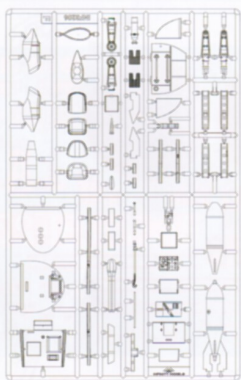

DECAL SHEET

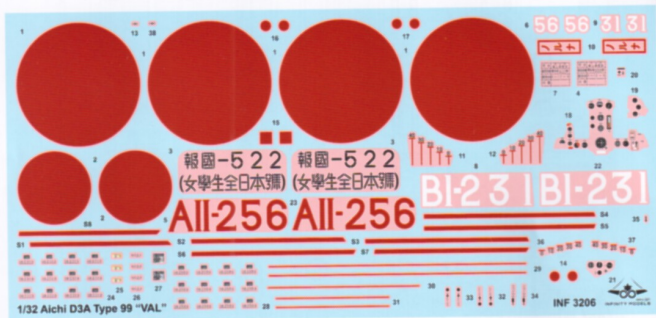

PHOTOETCHED PARTS

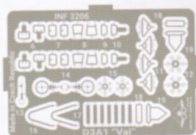
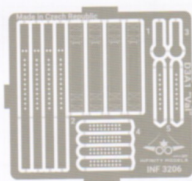

AK PAINT COLORS

MRP-004 / AK RC004
WHITE

MRP-184 / AK RC005
RED

MRP-419 / AK RC008
MARKING YELLOW

MRP-352 / AK 10008
GREEN

MRP-033 / AK 2275
PROPELLER COLOR

MRP-128 / AK RC020
SILVER METALLIC

MRP-427 / AK RC302
GREY

MRP-149 / AK RC015
GUN METAL

MRP-005 / AK RC001
BLACK

MRP-266 / AK RC503
RED CLEAR

MRP-267 / AK RC504
BLUE CLEAR

MRP-148 / AK 486
EXHAUST METAL

MRP-432 / AK 11895
COWLING COLOR

MRP-173 / AK RC022
TYRE-RUBBER MATT

MRP-115 / AK RC288
OCEAN GREY

MRP-425 / AK RC305
GREEN BLACK

MRP-411 / AK RC006
INSIGNIA RED

MRP-412 / AK 2068
COCKPIT COLOR

MRP-428 / AK 11892
OLIVE GREY

MRP-384 / AK 3069
BLUE

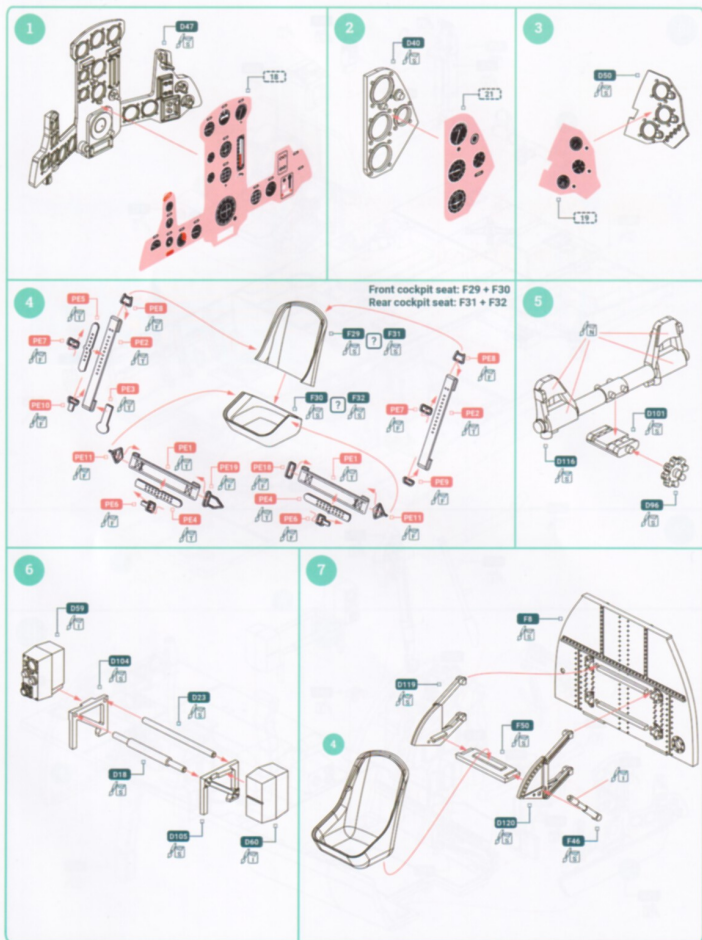

8

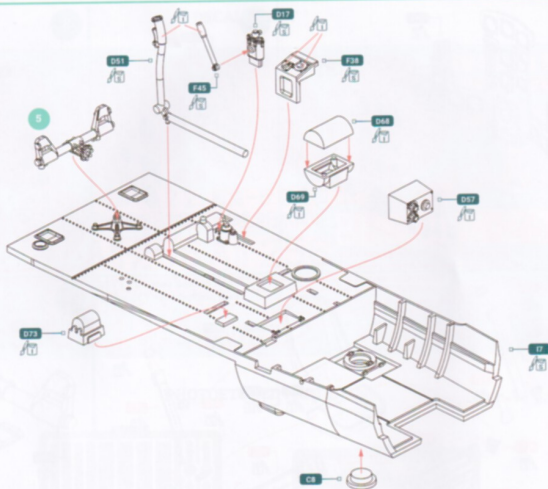

9

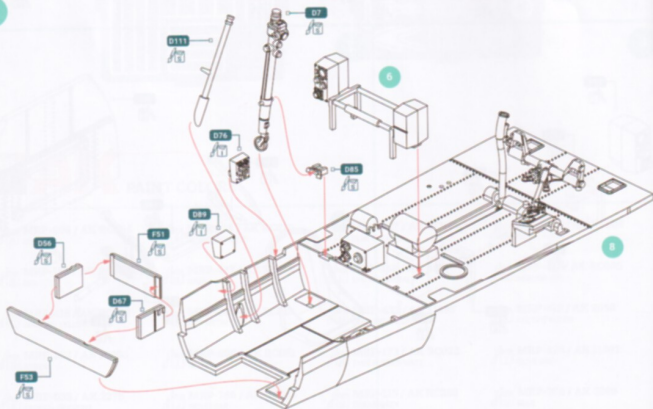

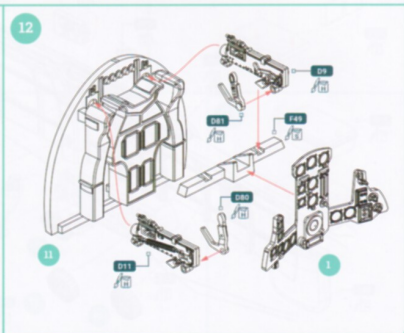
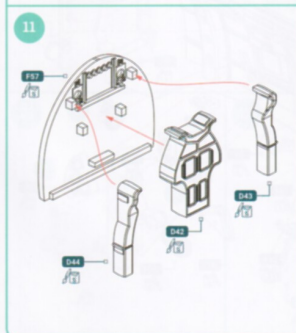
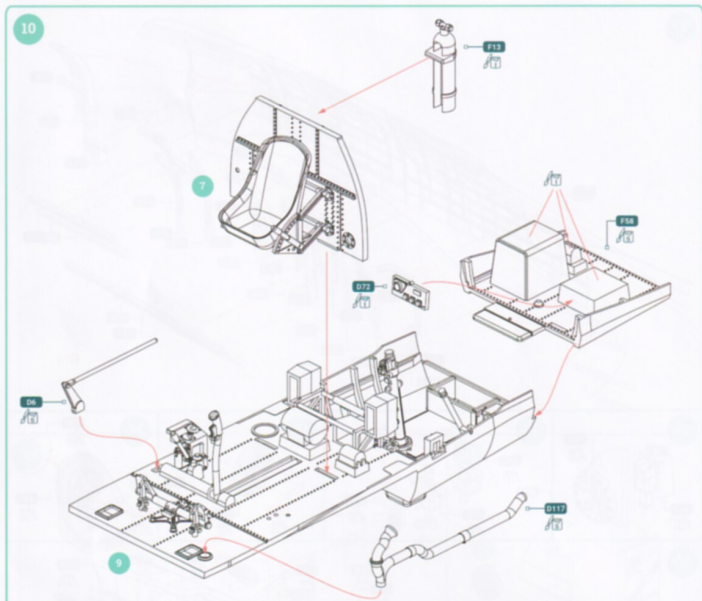

13

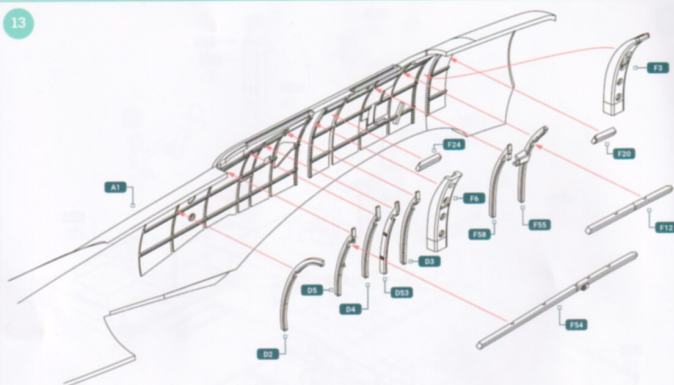

14

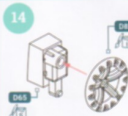

15

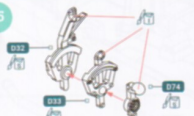

16

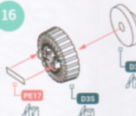

17

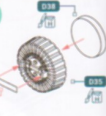

18

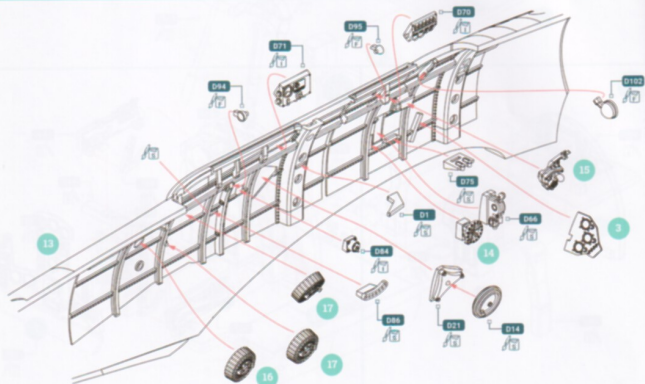

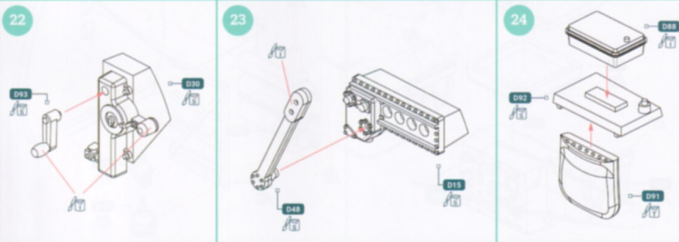
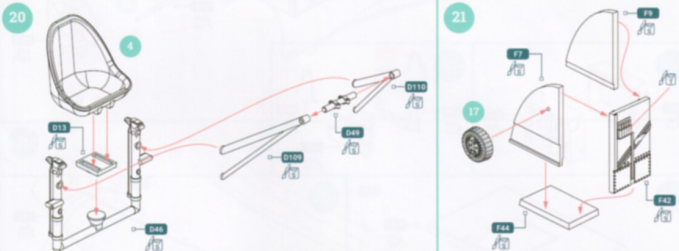
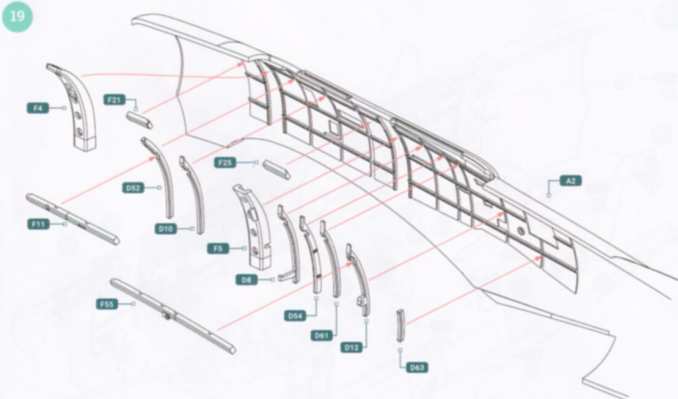

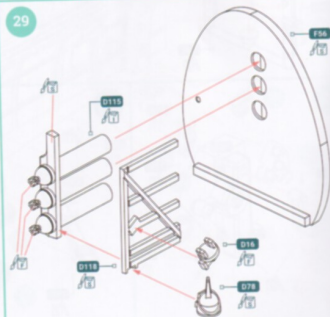
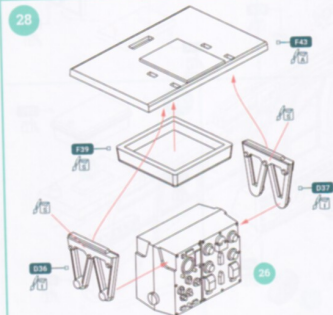
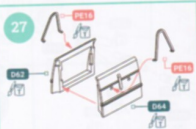
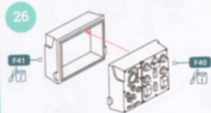
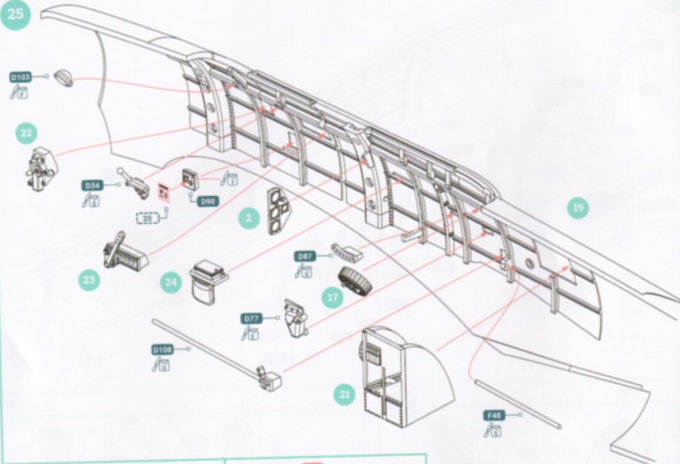

32

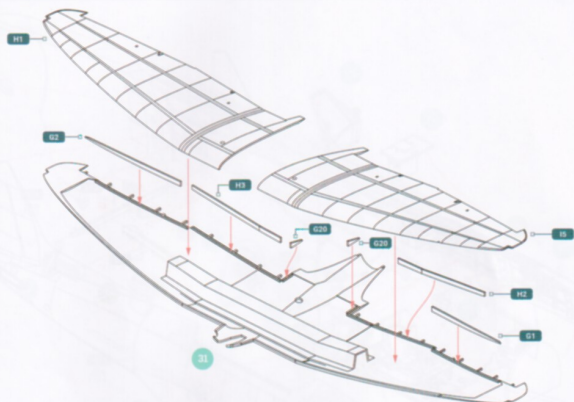

33

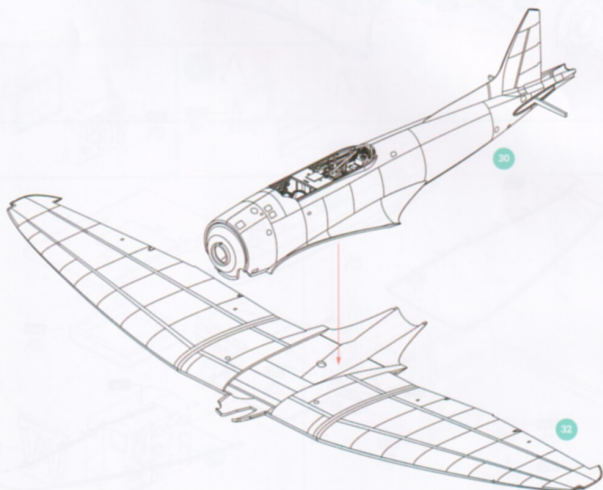

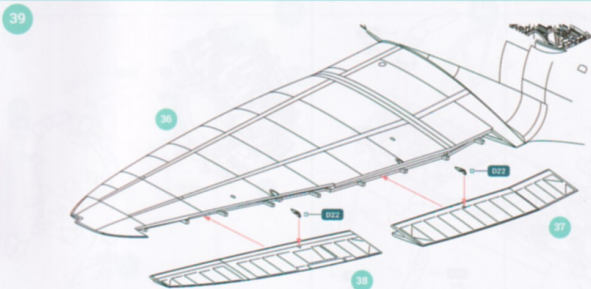
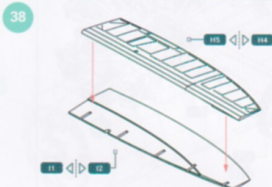
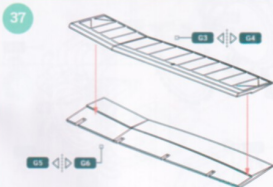
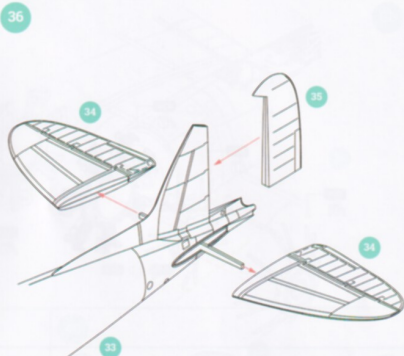
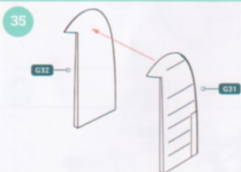
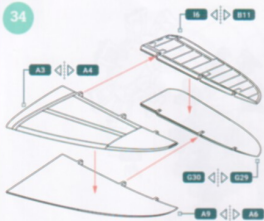

40

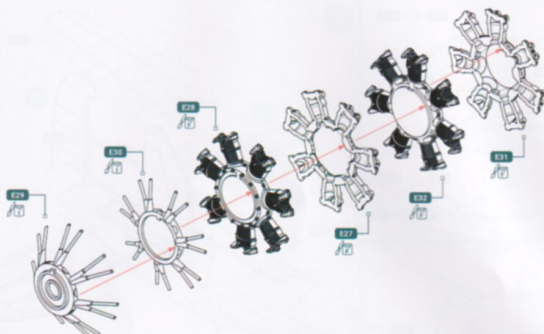

41

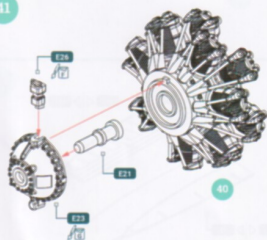

42

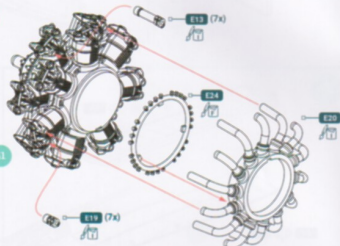

43

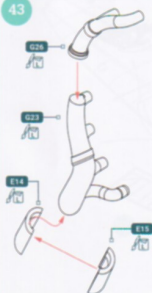

44



45

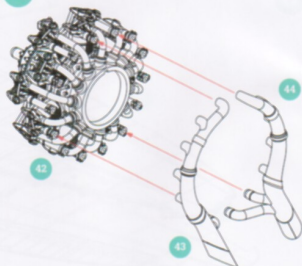

46

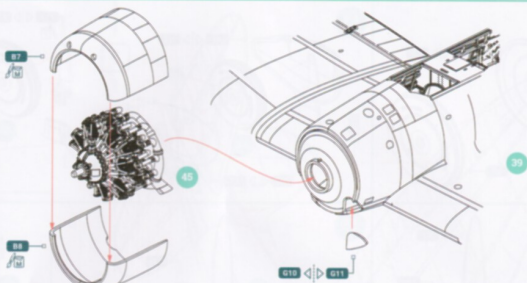

47

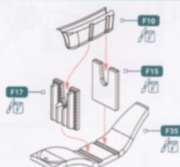

49

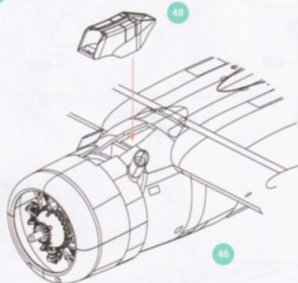

48



50

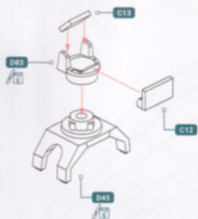

51

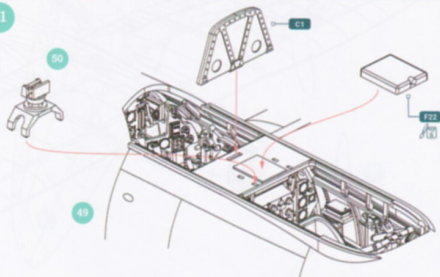

52

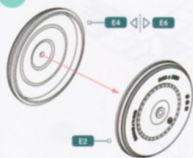

53

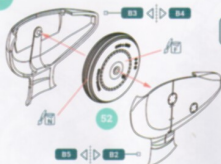

?

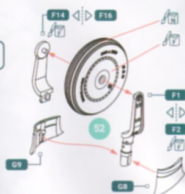

54

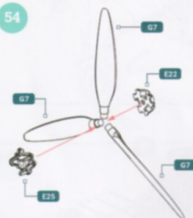

55



?



56

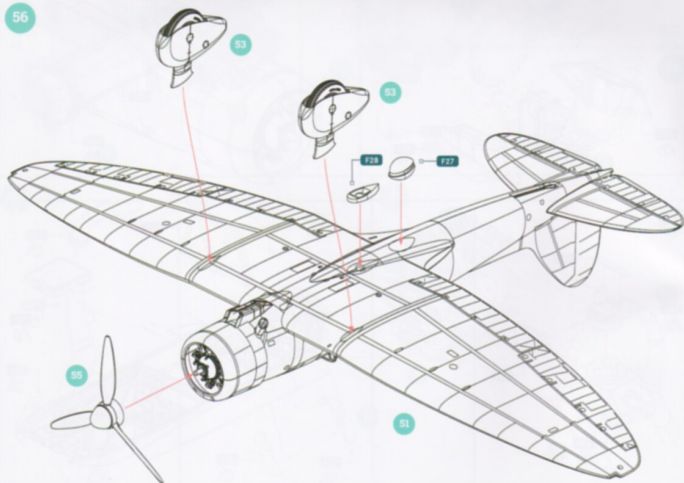

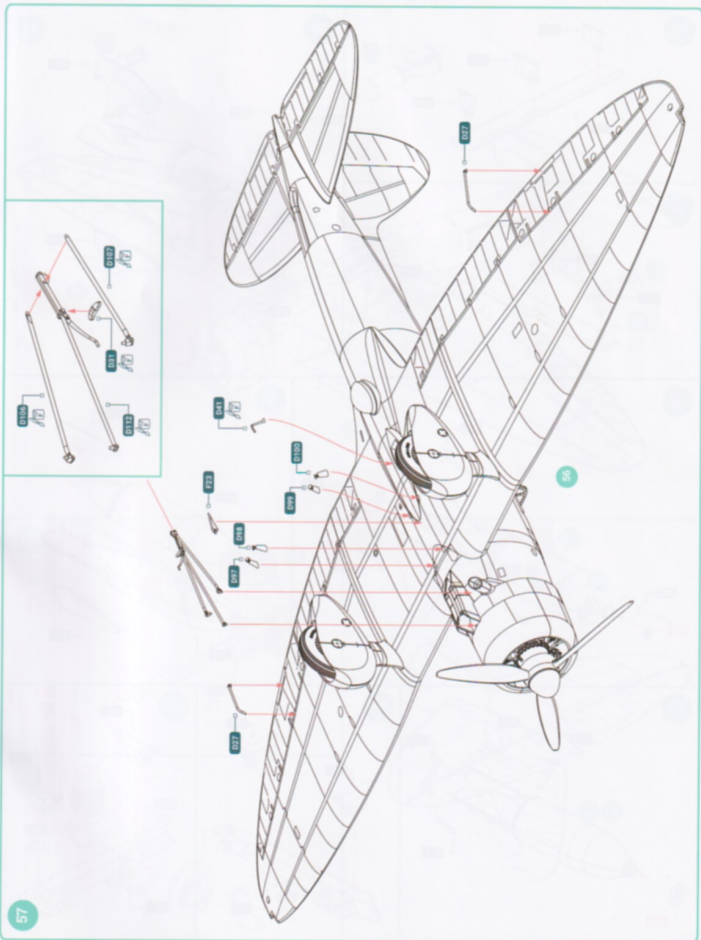

58

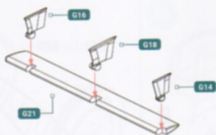

59

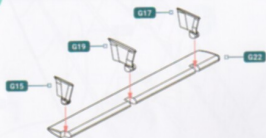

60

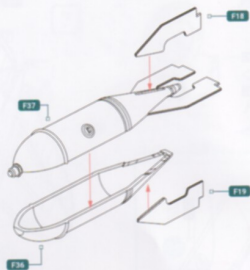

61

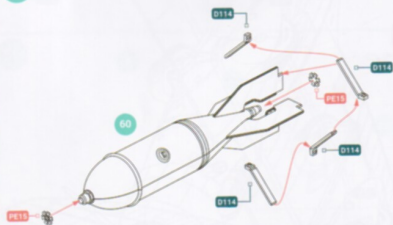

62

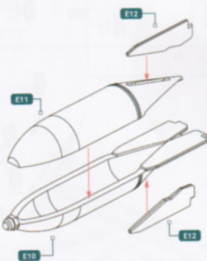

63

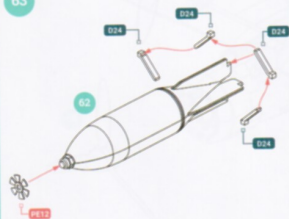

64

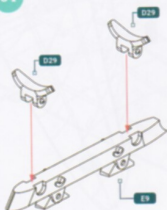

65

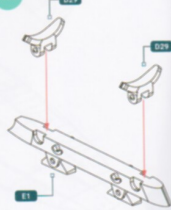

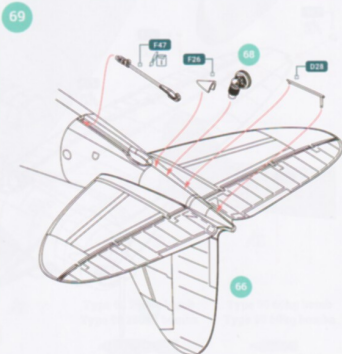
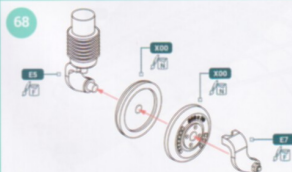
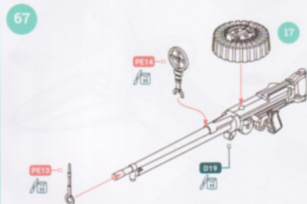
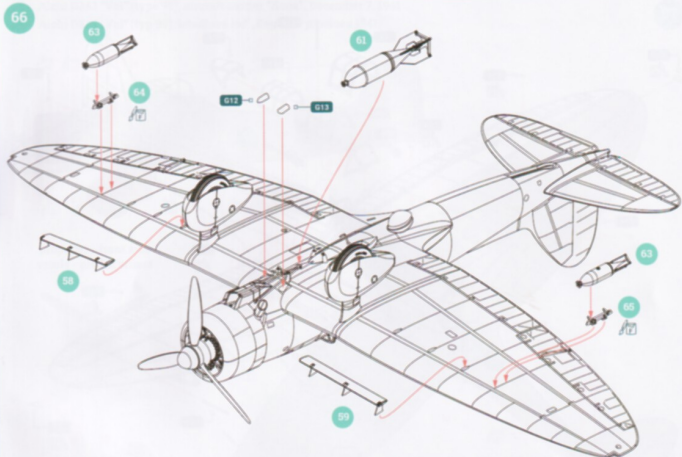

70

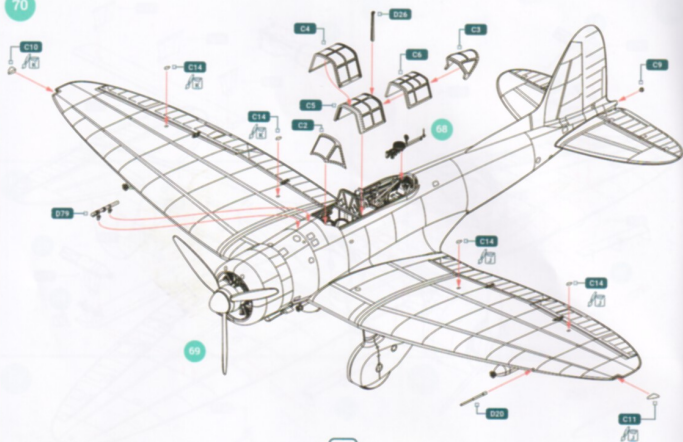

?

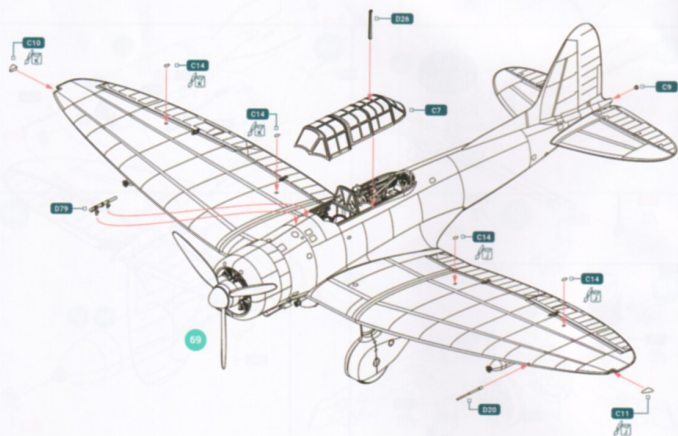

1

Aichi D3A1 "Val" (type 99), aircraft carrier "Kaga", December 7, 1941
 Aichi D3A1 „Val“ (typ 99), letadlová loď „Kaga“, 7. prosince 1941

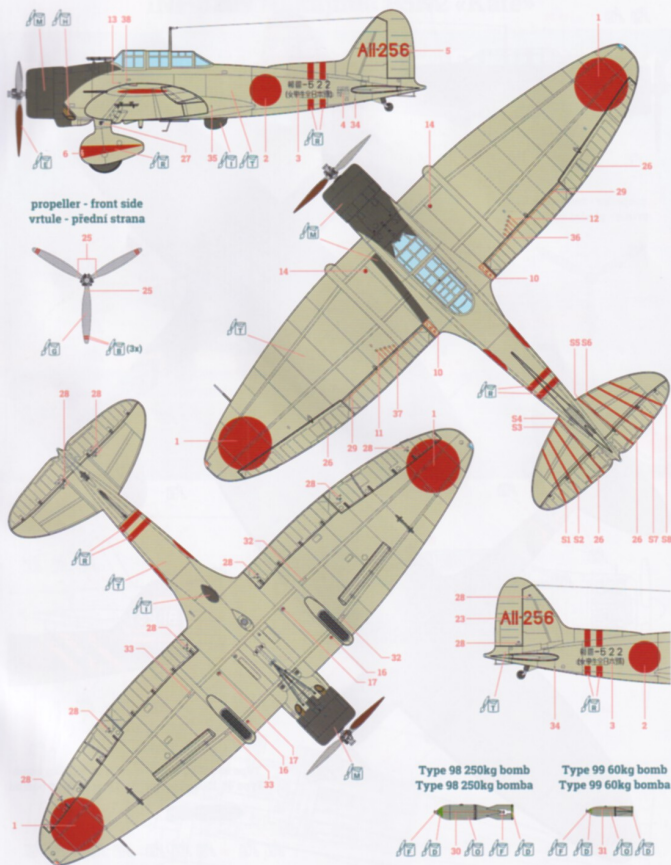

2

Aichi D3A1 "Val" (type 99), aircraft carrier "Soryu", December 7, 1941

Aichi D3A1 „Val“ (typ 99), letadlová loď „Soryu“, 7. prosince 1941



Připravujeme pro Vás / Coming soon

Právě ve vývoji / Currently in development

INF 3209 Nakajima B5N2 «Kate»



Nakajima B5N2 Kate

1/32 AIRCRAFT SERIES #3209 — FUSELAGE LENGTH 119 MM



1/32
plastic by HPH

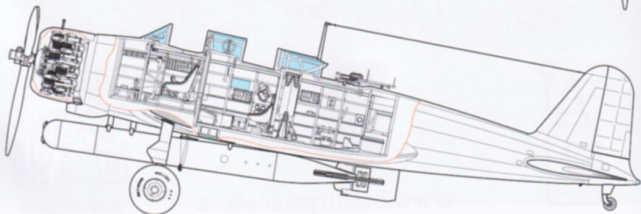
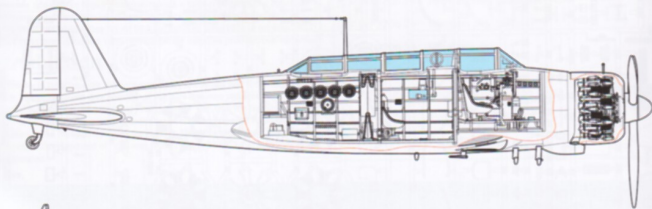

Připravujeme pro Vás / Coming soon

Právě ve vývoji / Currently in development

INF 3209 Nakajima B5N2 «Kate»

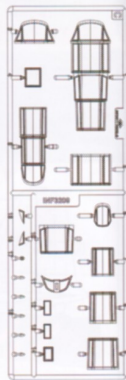
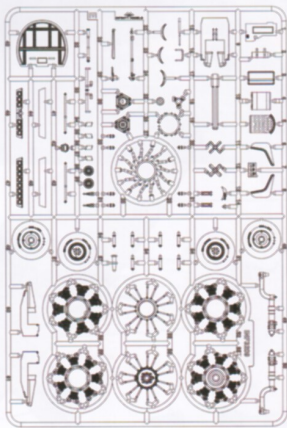
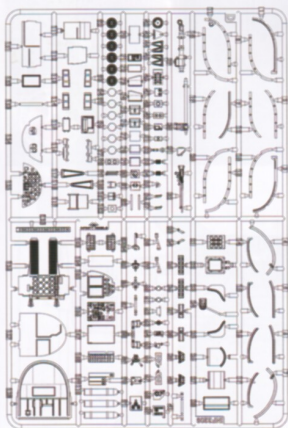
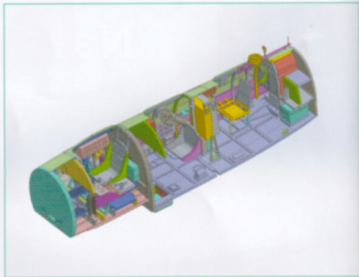
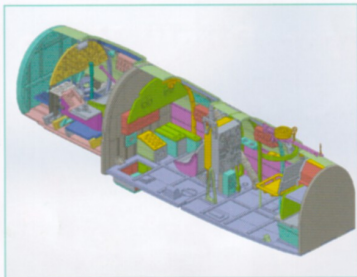

Více na / More on

www.infinitymodels.cz



Scan with phone