

LG. ROUNDELS UPPER PORT AND LOWER STARBOARD WINGS
 B-102 UPPER STARBOARD AND LOWER PORT WINGS

CANBERA B-62 1 GRUPPO AERO
 DE BOBBARDEO BASED AT GENERAL
 URQUIZA AIR BASE, PARANA, ARGENTINA

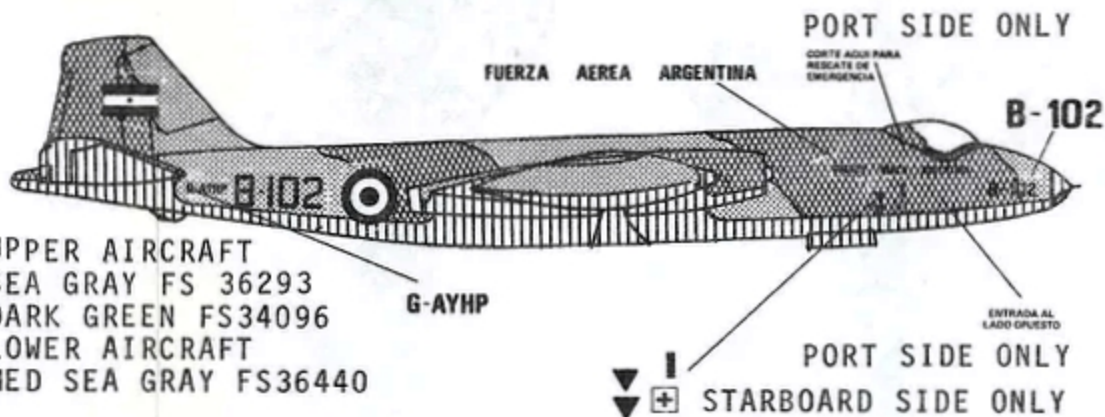
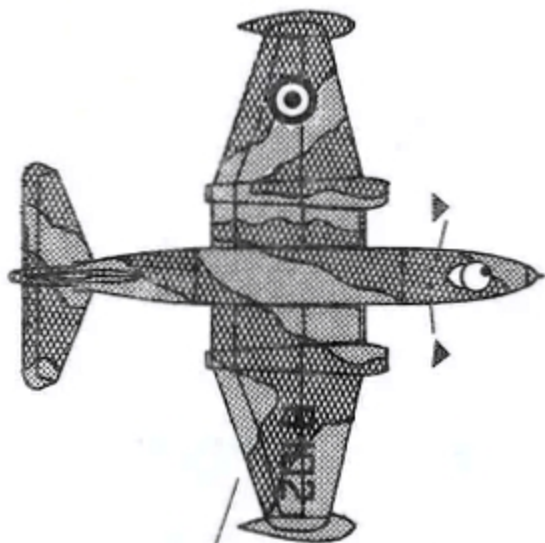

UPPER AIRCRAFT
 SEA GRAY FS 36293
 DARK GREEN FS34096
 LOWER AIRCRAFT
 MED SEA GRAY FS36440

BLACK ANTENA
 LT. GRAY

CAMOUFLAGE PATTERN
 IS PROVISIONAL

LG. ROUNDELS UPPER AND LOWER WINGS
 SM. ROUNDELS ON FUSELAGE

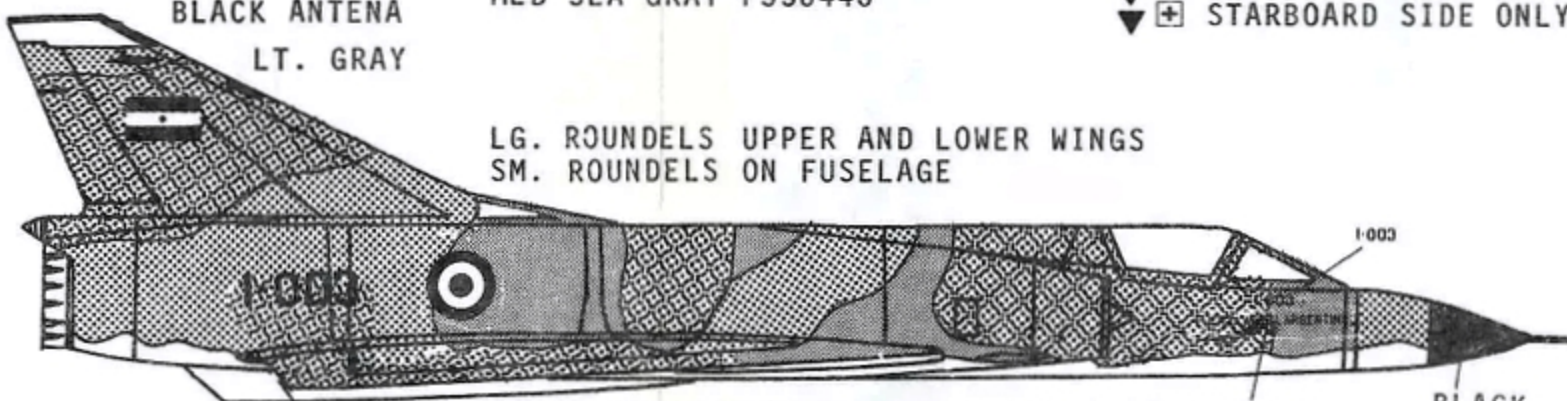

DASSAULT MIRAGE IIIE-A 7 BRIGADA AEREA
 BASED AT JOSE C POZ AIR BASE

UPPER AIRCRAFT
 GREEN FS34102
 GREEN FS34064
 TAN FS30219
 LOWER AIRCRAFT
 LT. GULL GRAY FS36622

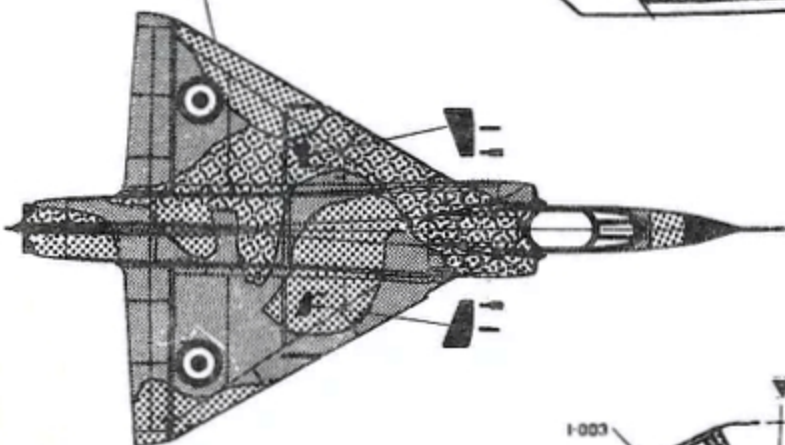







I-003 FOR NOSE GEAR DOOR

BOTH SIDES

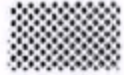
FUERZA AEREA ARGENTINA

YELLOW PORT SIDE

-  FS 34096
-  FS 34064
-  FS 34102
-  FS 30219
-  FS 36293
-  FS 36440

RESEARCH BY DON GARRETT
 REFERENCES
 AIR INTERNATIONAL AND
 AIR FORCES OF THE WORLD
 NO ROUNDELS ON WINGS

CAMOUFLAGE PATTERN
 IS PROVISIONAL

72-352

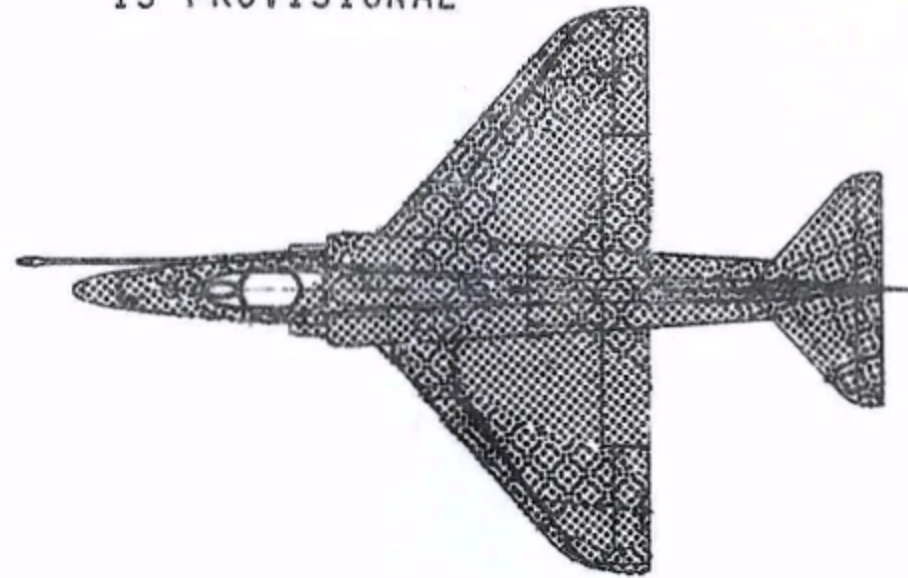

DOUGLAS A-4B SKYHAWK
 5 BRIGADE AEREA BASED
 AT VILLA REYNOLDS
 UPPER AIRCRAFT
 BROWN FS30219
 GREEN FS34102
 LOWER AIRCRAFT
 LT GRAY FS36222

DECALS HAVE BEEN PROVIDED TO DO ALTERNATE VERSIONS 228
 AND 235, PLACE THEM IN THE SAME PLACE AS FOR 233

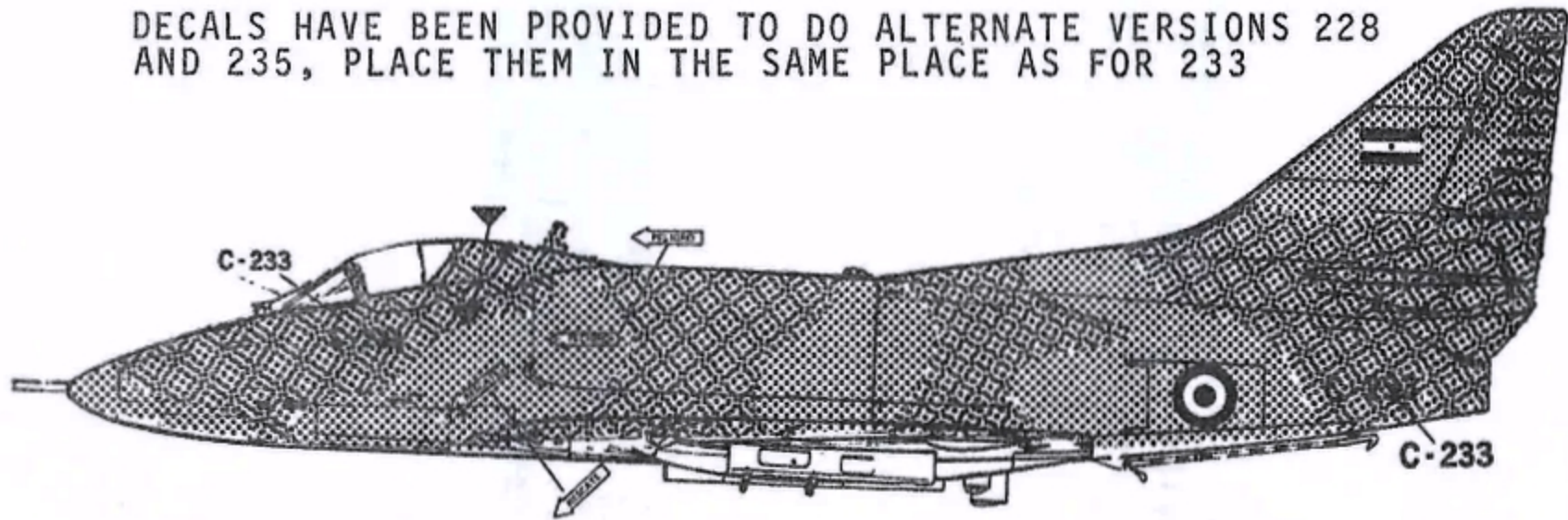

RED WING TIPS

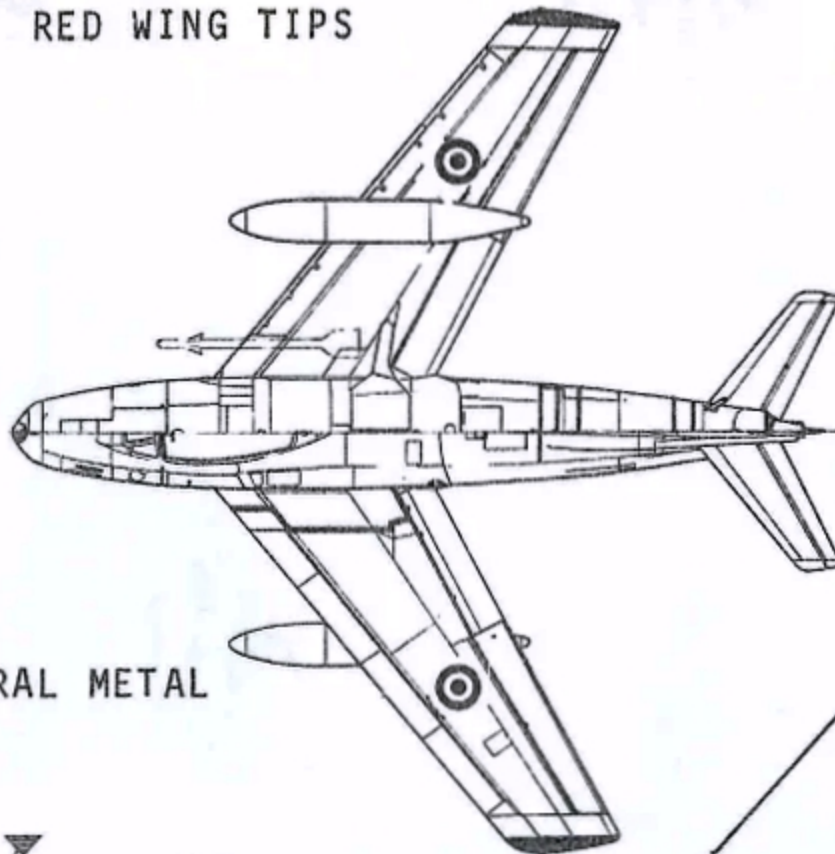

F-86F SABRE
 OVERALL AIRCRAFT NATURAL METAL

BLACK

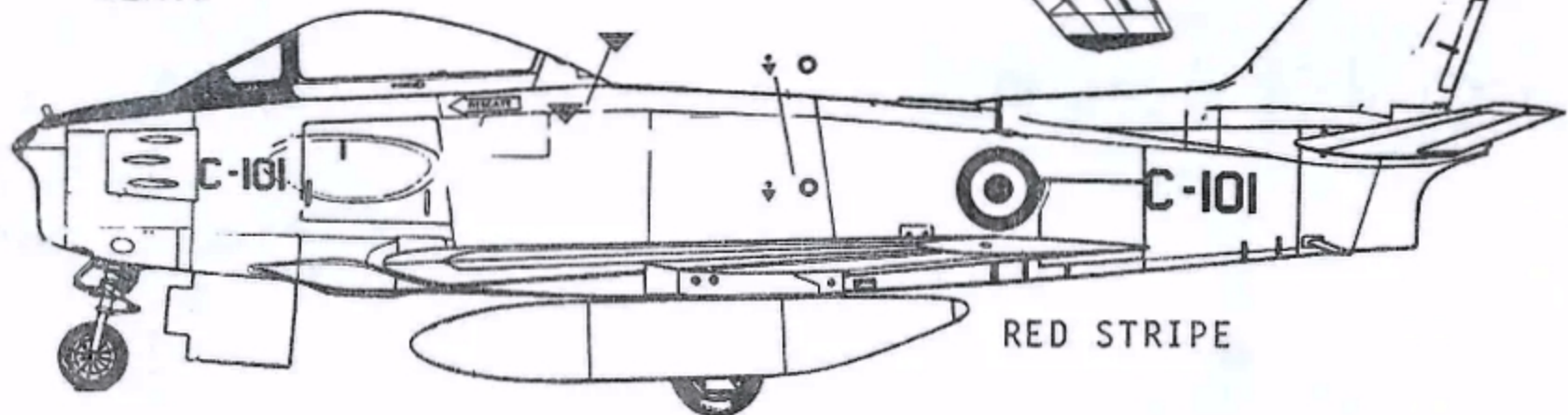

RED STRIPE