

# 1:72 SCALE

## Soviet MIG-3



### EASY ASSEMBLY AUTHENTIC KIT



cyanoacrylate glue  
强力胶



weight  
配重



make hole  
钻孔



cut / remove  
切除



option  
选择



no cement  
不涂胶水



decal  
贴纸



bend  
弯曲

#### The way to apply the decals

1. Cut off the decal from the decal paper and put it into the warm water 40°C for 10 seconds.
2. Take the decal from the water and put it on a piece of clean cloth.
3. Remove the decal slowly from the paper to the targeted location by a wet finger.
4. Use a piece of dry and soft cloth to press it gently on the decal until it getting dry and no bubble existing.

#### 水贴纸的使用方法:

- 一. 把相关的印花从水贴纸上剪下, 放入40°C左右的温水中浸10秒。
- 二. 然后将印花放在干净的布上。
- 三. 拿上印花纸板, 手指蘸水将印花移到适当的位置。
- 四. 用软干布轻压印花直至水干, 气泡消失。

12th IAP Moscow Air Defence 1942

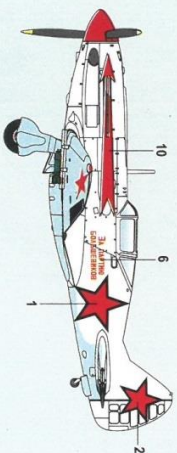

H | 316 316

白色  
White Insignia

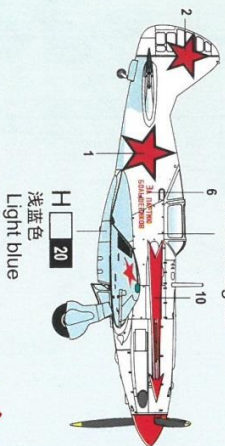

H | 20  
浅蓝色  
Light blue

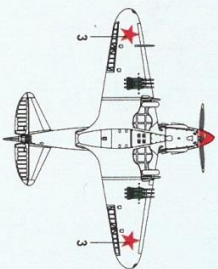
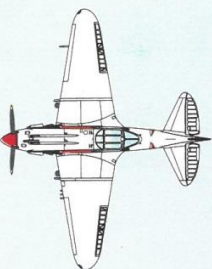

Porkryshkin 1941/1942



H | 304 304

橄榄色  
Olive Drab

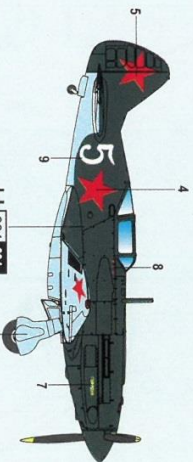

H | 304 304

橄榄色  
Olive Drab

H | 20  
浅蓝色  
Light blue



涂装同标识指示  
Painting & Marking guide

H | X GUNZE SANGYO AQUEOUS HOBBY COLOUR X GUNZE SANGYO MR COLOUR

\* Some paints may not be available in your country. Please check your local hobby shop for substitute

# 部品图 Parts

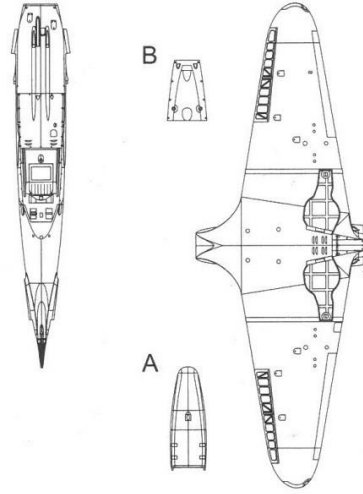
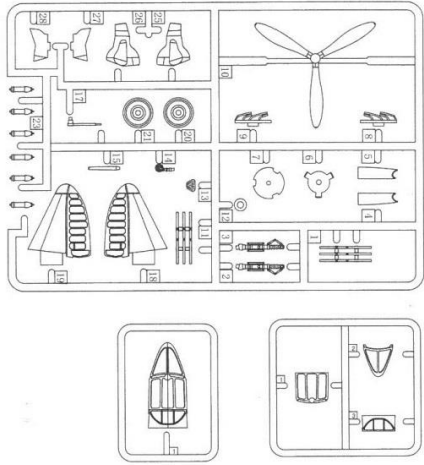

1

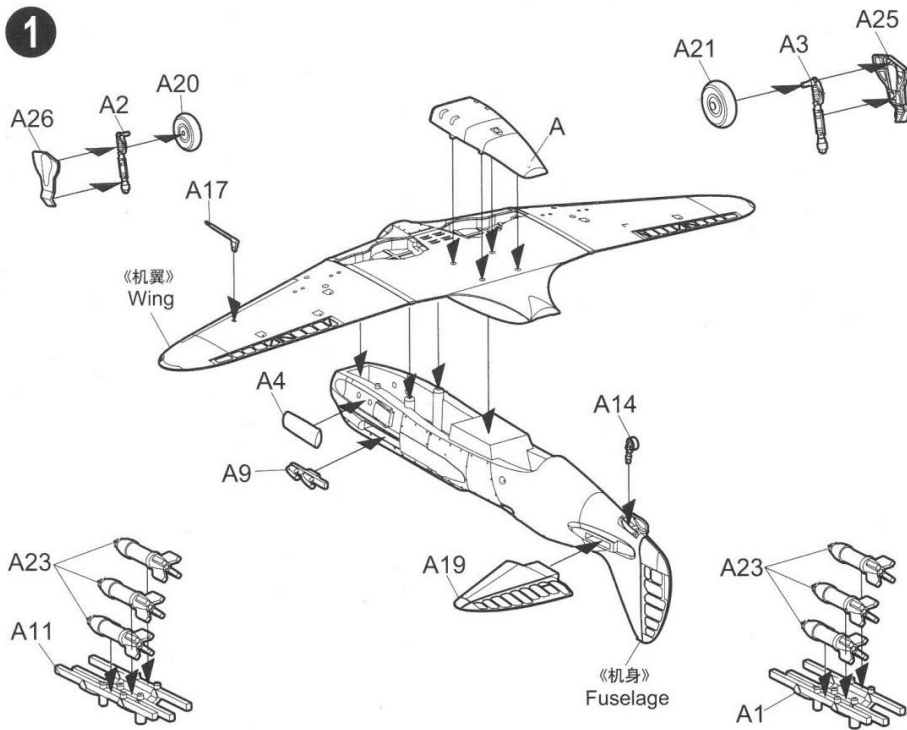

2

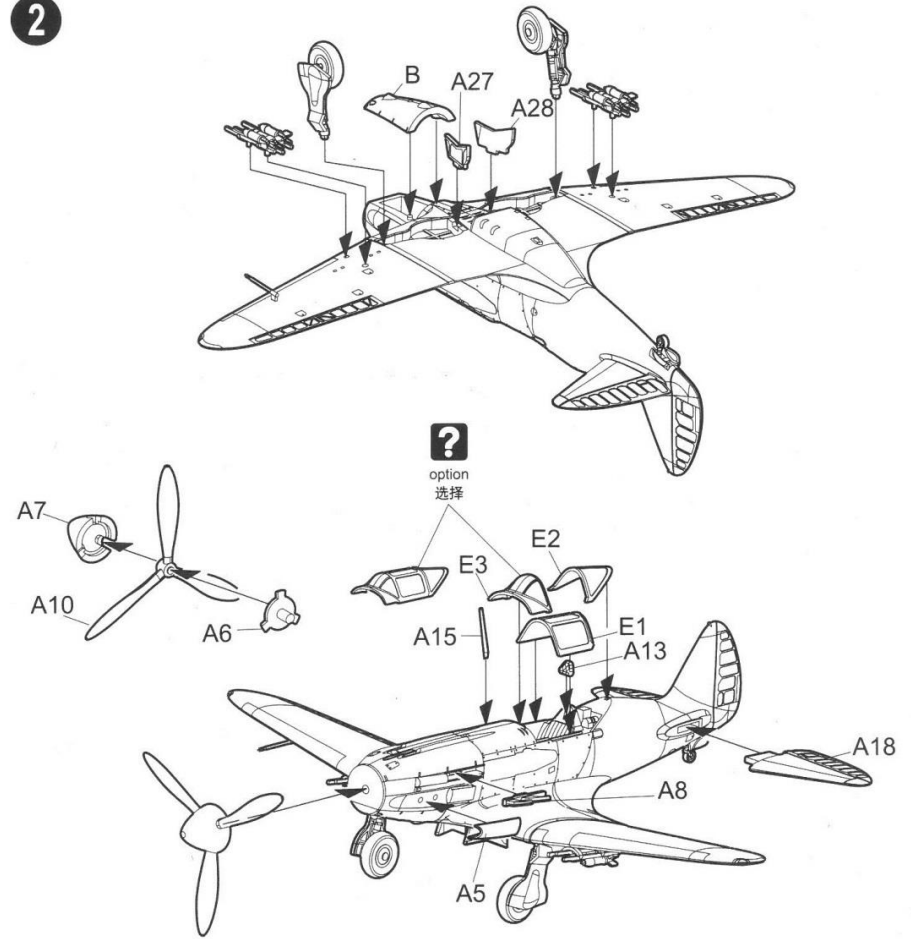

3

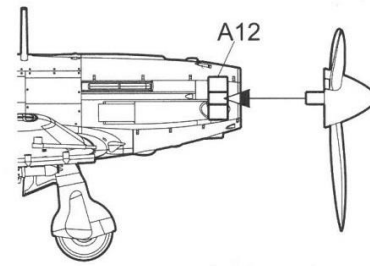

4

