



No.28 © 2019  
SCALE 1:72

# De Vliegende Nederlanders

No.28 © 2019  
SCALE 1:72

Marine Luchtvaartdienst Van Koninklijke Marine

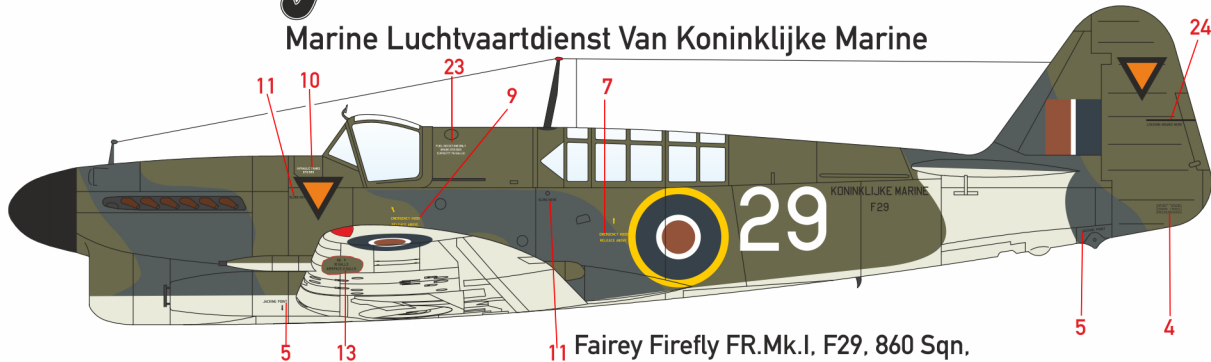

Fairey Firefly FR.Mk.I, F29, 860 Sqn.  
Hr.Ms. Karel Doorman, Nederlands-Indië, Augustus 1946.

Supermarine Sea Otter ABR.Mk.I, 18-4, VSQ 320,  
1e Westreis, Februari 1950.

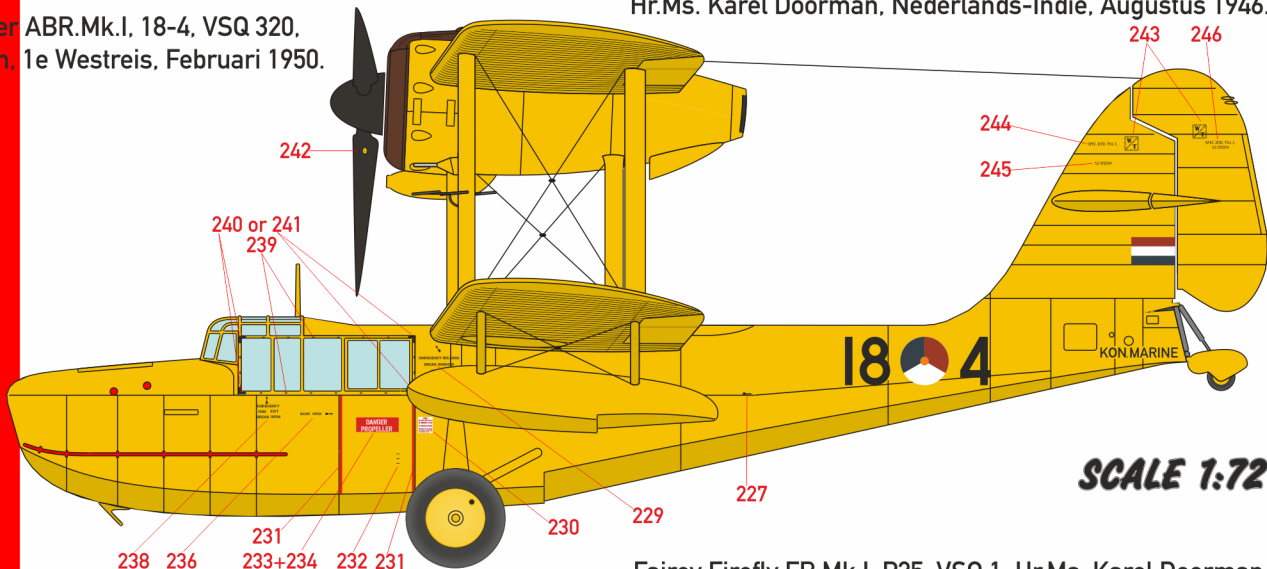

SCALE 1:72

For experienced  
modellers

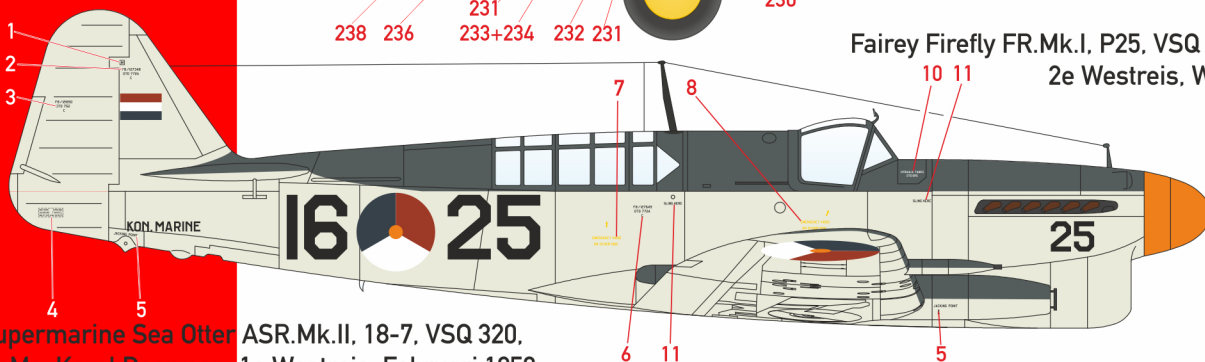

Fairey Firefly FR.Mk.I, P25, VSQ 1, Hr.Ms. Karel Doorman,  
2e Westreis, West-Indië, Hato, Curaçao,  
Januari 1952.

Supermarine Sea Otter ASR.Mk.II, 18-7, VSQ 320,  
1e Westreis, Februari 1950.

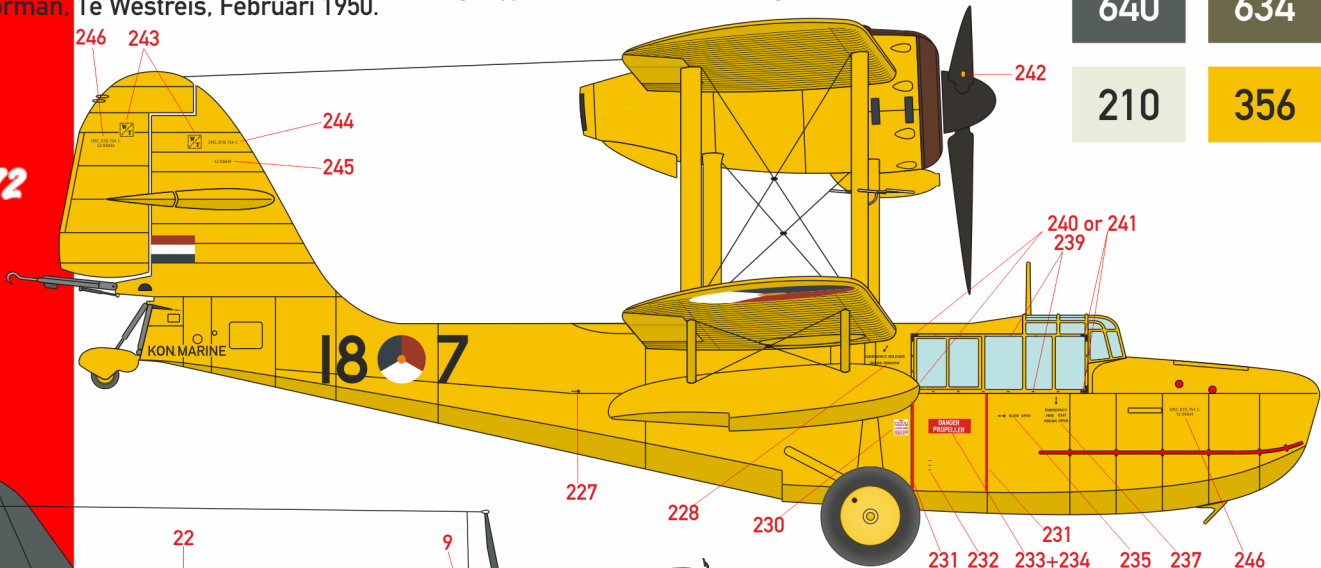

BS 381 Color chart

640	634
210	356

SCALE 1:72

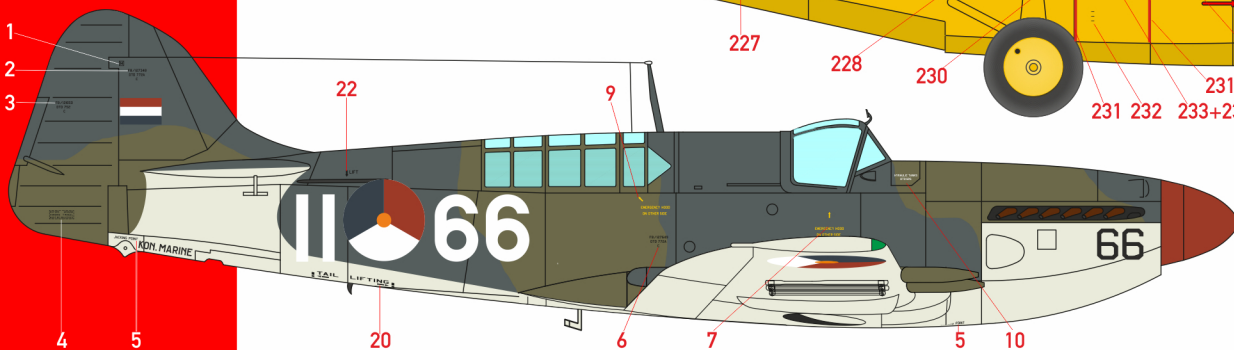

Fairey Firefly F.Mk.IV, K66, VSQ 1, Hr.Ms. Karel Doorman, 1e Westreis, West-Indië, Hato, Curaçao, Februari 1950.

CTAMODELS.COM

CTAMODELS.COM

# De Vliegende Nederlanders

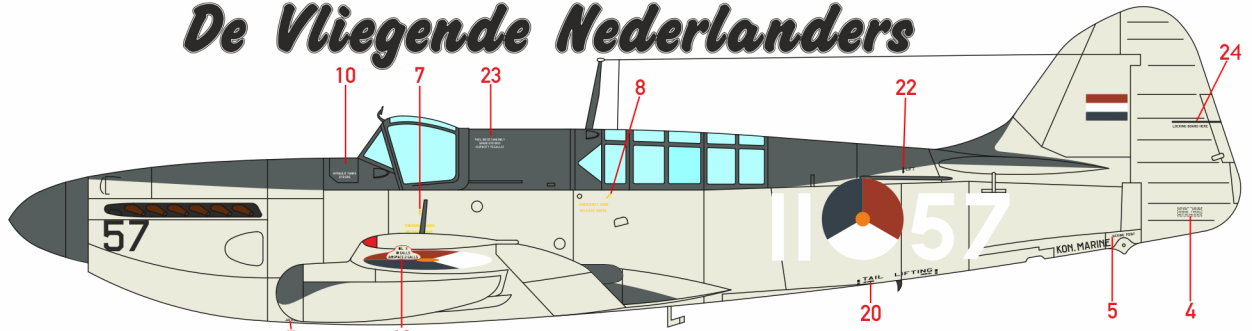

Fairey Firefly F.Mk.IV, K57, VSQ 4, Hr.Ms. Karel Doorman, 1e Westreis, West-Indië, Bonaire, Februari 1950.

No.28 © 2019  
SCALE 1:72

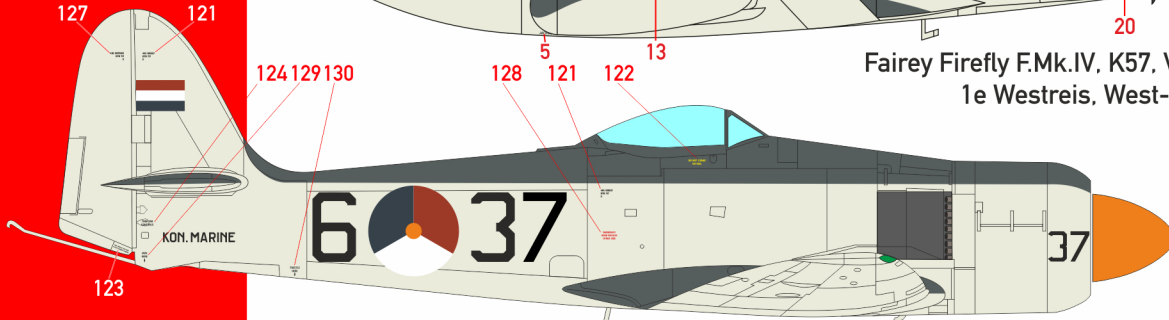

Fokker Sea Fury FB. Mk.51, F-37, VSQ 860. Hr.Ms. Karel Doorman, Februari 1954.

For experienced  
modellers

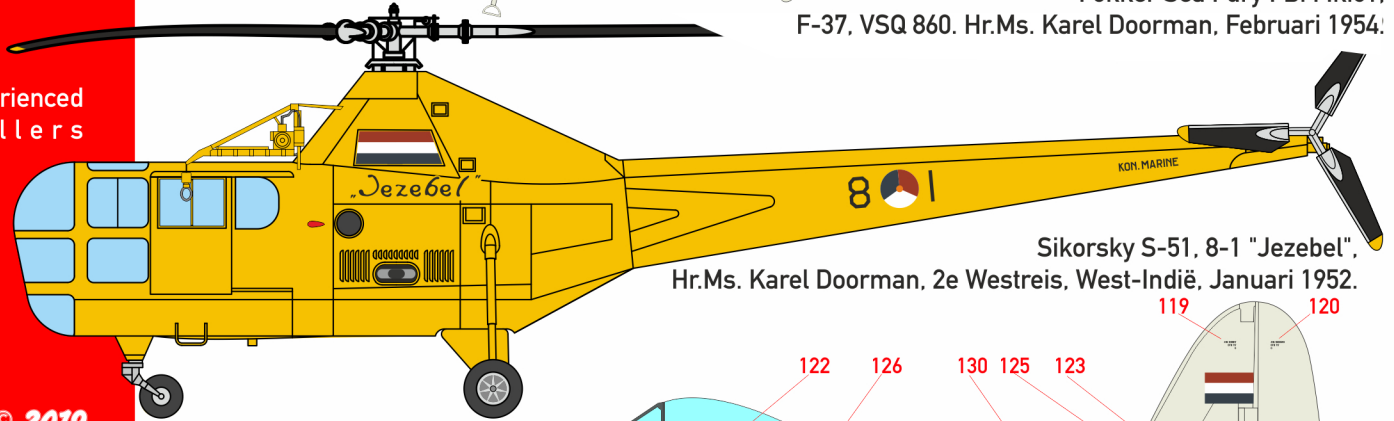

Sikorsky S-51, 8-1 "Jezebel", Hr.Ms. Karel Doorman, 2e Westreis, West-Indië, Januari 1952.

No.28 © 2019  
SCALE 1:72

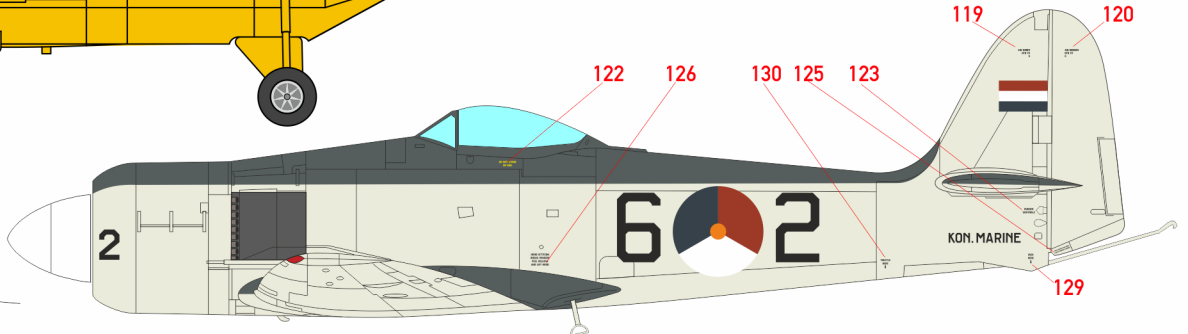

Hawker Sea Fury FB. Mk.60, F-2, VSQ 860, Hr.Ms. Karel Doorman, NATO oefening "Castanets", Juli 1952.

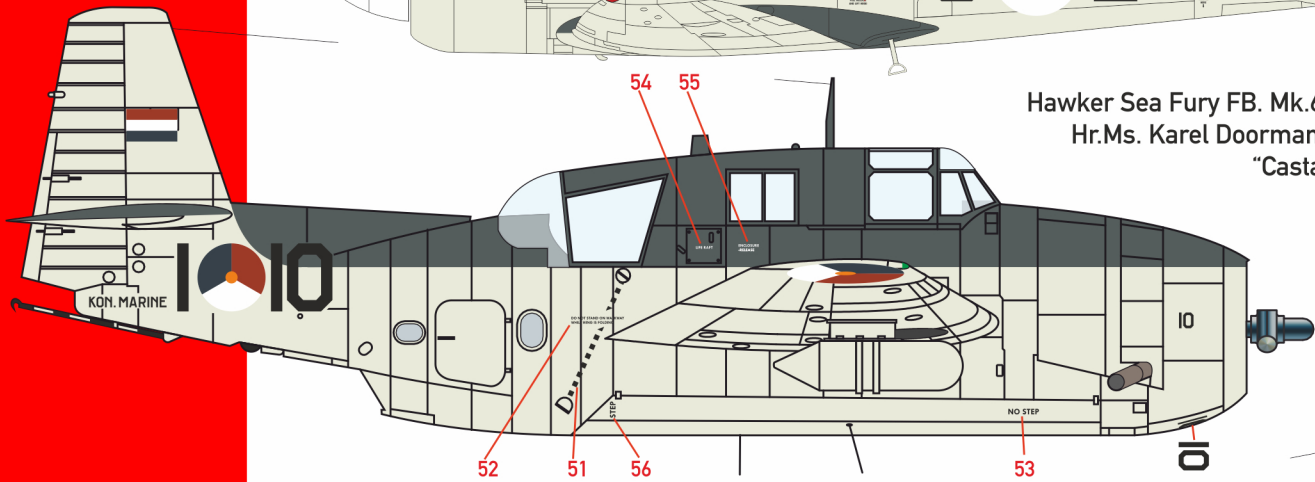

General Motors TBM-3S2 Avenger, A-10, VSQ 2, Hr.Ms. Karel Doorman, 3e Westreis, Februari 1959.

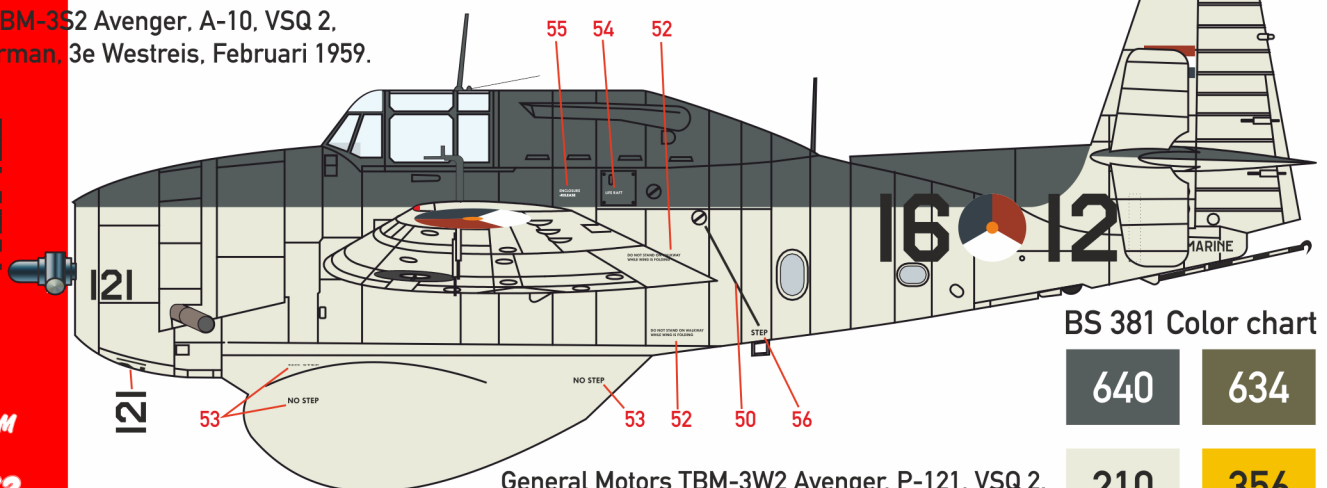

General Motors TBM-3W2 Avenger, P-121, VSQ 2, Hr.Ms. Karel Doorman, 3e Westreis, Februari 1959.

BS 381 Color chart

640	634
210	356





# De Vliegende Nederlanders



No.28 © 2019  
SCALE 1:72

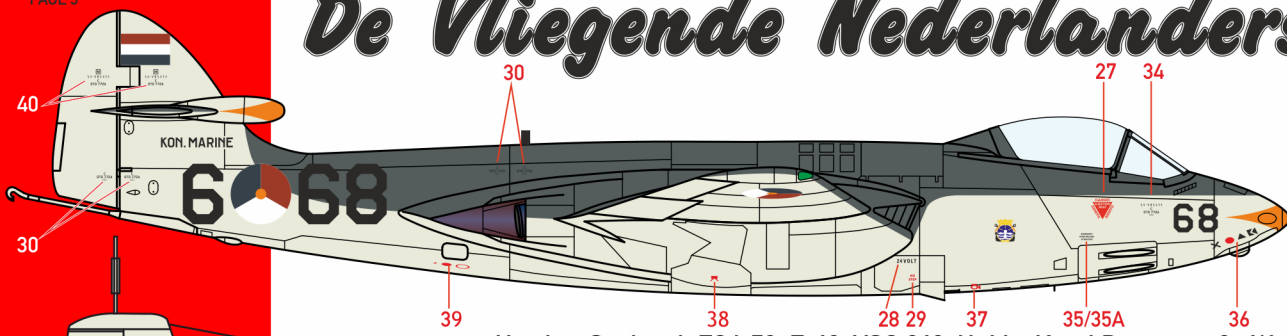

Hawker Seahawk FGA.50, F-68, VSQ 860, Hr.Ms. Karel Doorman, 3e Westreis, Februari 1959.

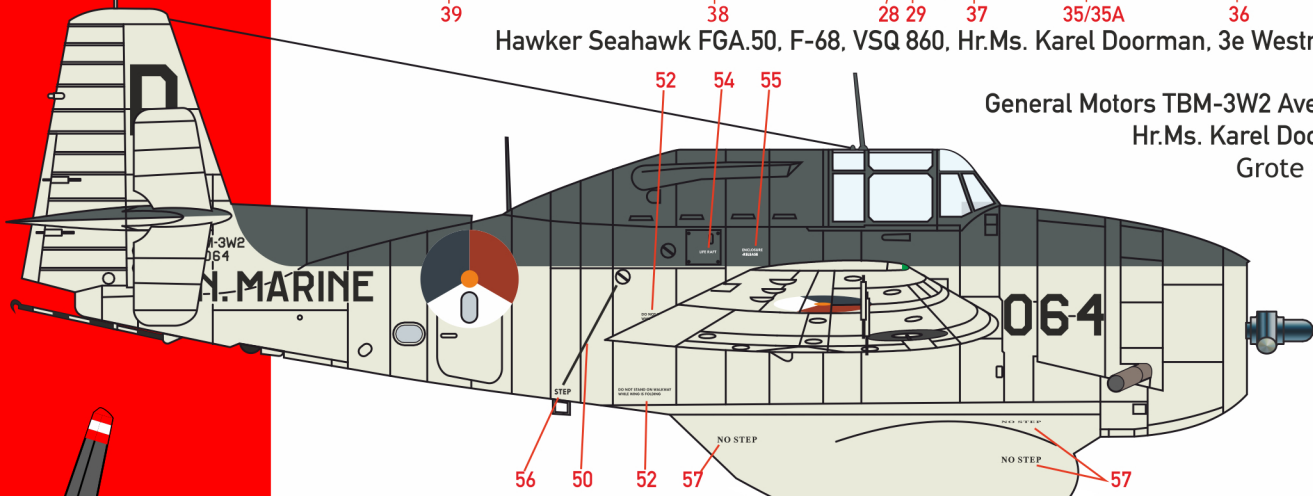

General Motors TBM-3W2 Avenger, D064, VSQ 2, Hr.Ms. Karel Doorman, Wereldreis, Grote Ocean, Juli 1960.

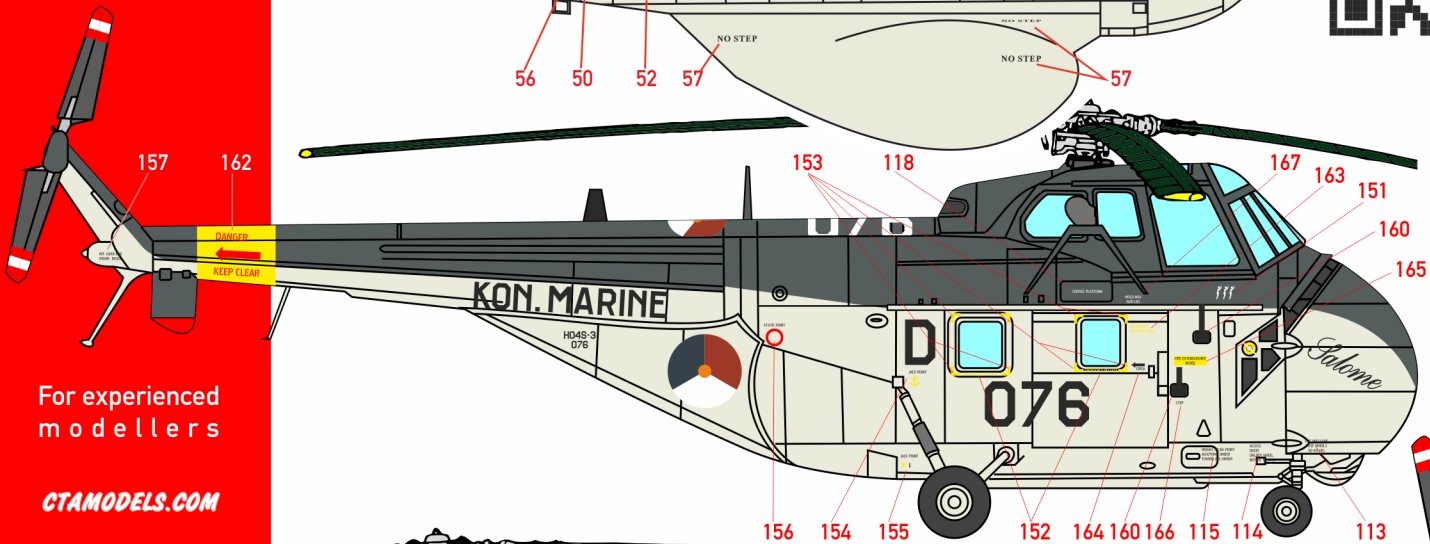

For experienced modellers

CTAMODELS.COM

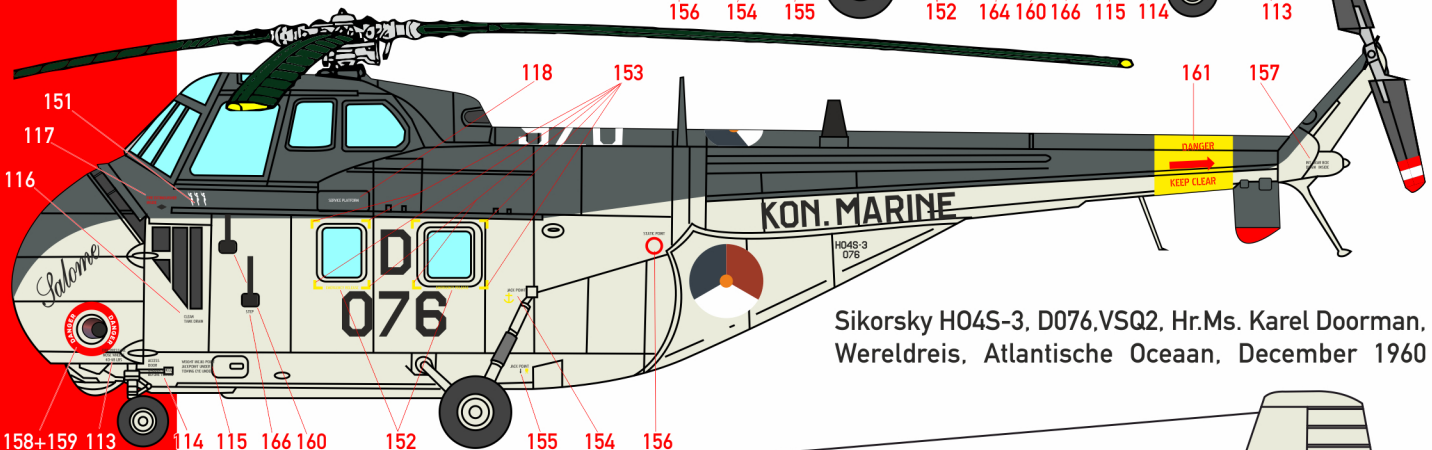

Sikorsky HO4S-3, D076, VSQ2, Hr.Ms. Karel Doorman, Wereldreis, Atlantische Ocean, December 1960

BS 381 Color chart

640	634
210	356

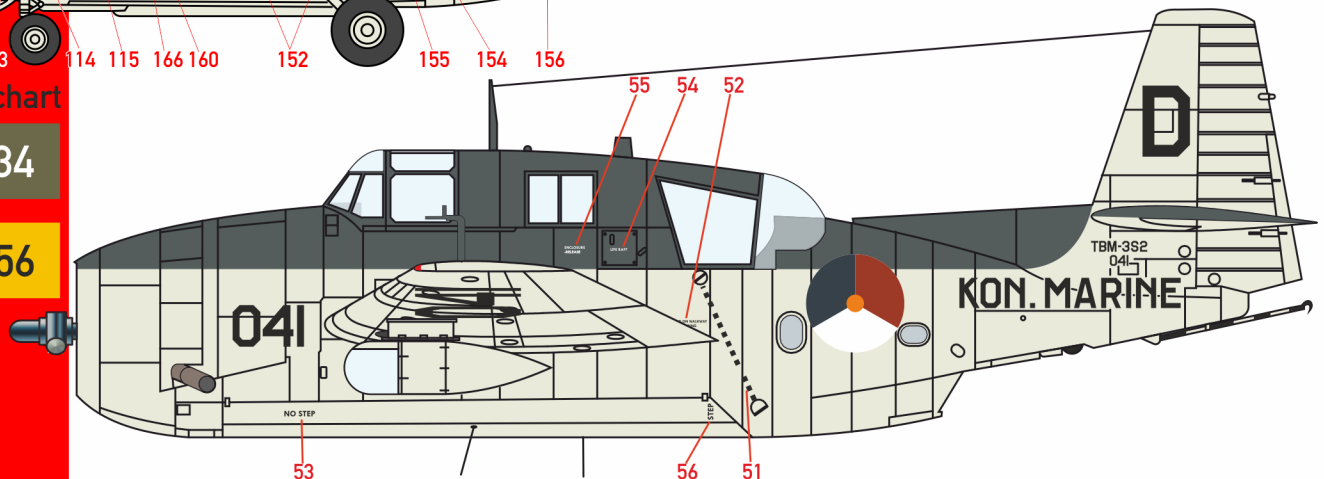

General Motors TBM-3S2 Avenger, D041, VSQ 2, Hr.Ms. Karel Doorman, Wereldreis, Indische Ocean, Juni 1960.

SCALE 1:72

CTAMODELS.COM



No.28 © 2019  
SCALE 1:72

# De Vliegende Nederlanders

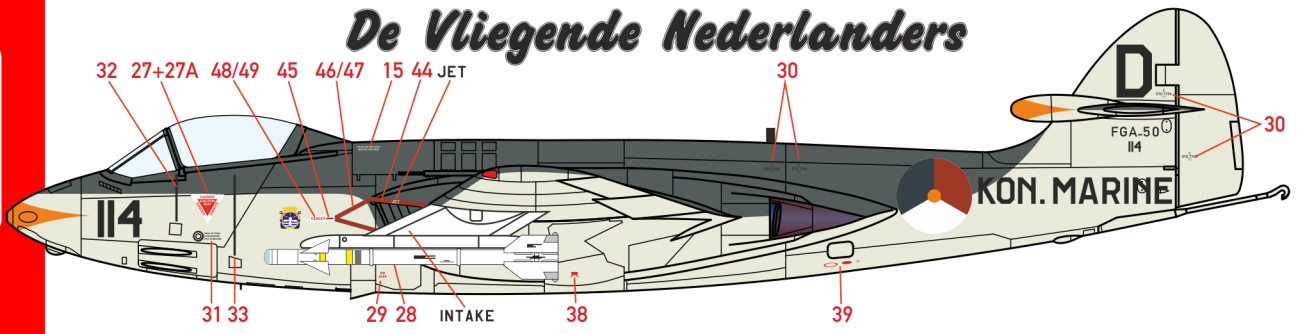

Hawker Seahawk FGA.50, D114, VSQ 860, Hr.Ms. Karel Doorman, Wereldreis, Zuid-Atlantische Oceaan, November 1960.

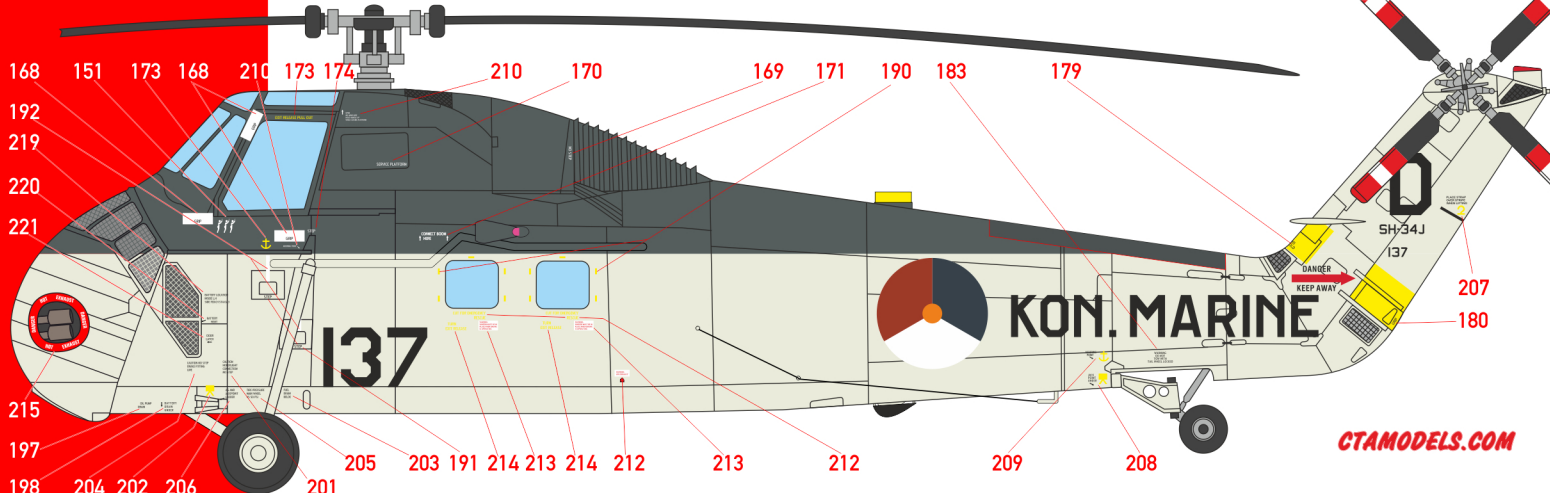

CTAMODELS.COM

Sikorsky SH-34J, D137, VSQ8, Hr.Ms. Karel Doorman en ook Hr.Ms. Poolster, Atlantische Oceaan in de buurt van Canarische eilanden, November 1964.

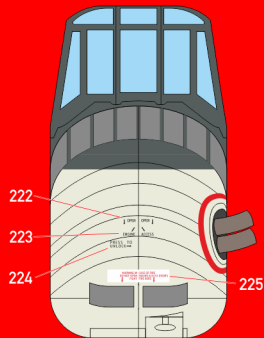

SCALE 1:72

## BS 381 Color chart



For experienced modellers

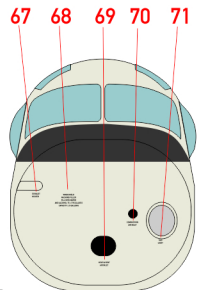
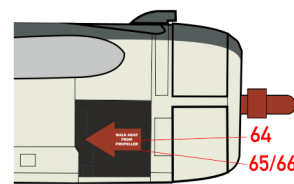
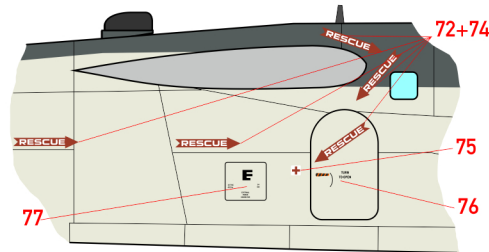

Grumman S-2A Tracker, D173, VSQ4, Hr.Ms. Karel Doorman, De Laatste Reis, Atlantische Oceaan, Santa Cruz de Tenerife, Februari 1968.

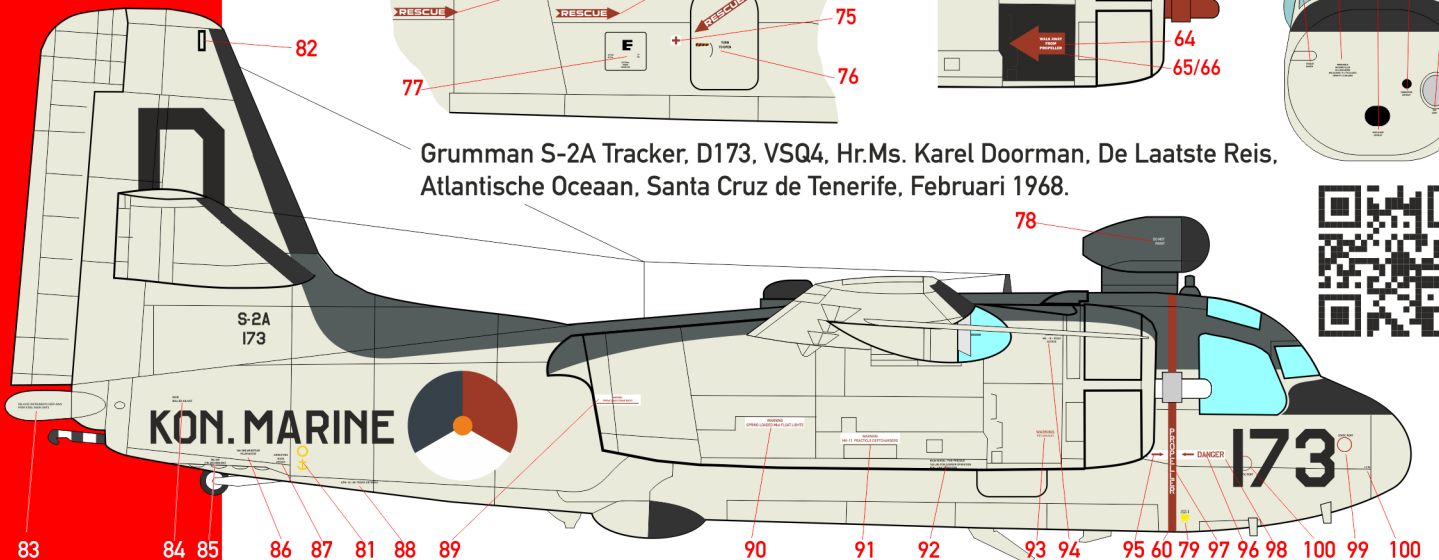



# De Vliegende Nederlanders

De Havilland Canada CS2F-1 Tracker, H196, VSQ1, 111 110 109 82  
gestationeerd op Hato Curaçao, vluchten vanaf het dek  
Hr.Ms. Karel Doorman, 5e Westreis, Het Caribisch gebied, April 1964.

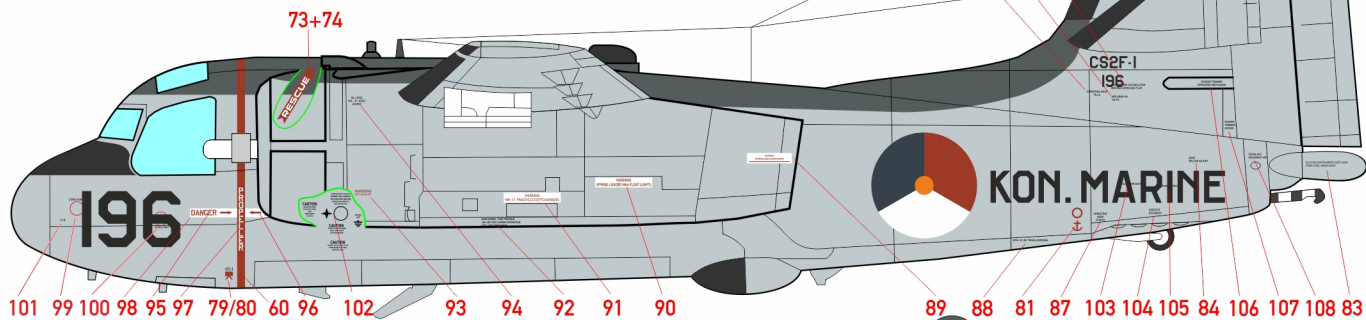

627 640 634 210

BS 381 Color chart

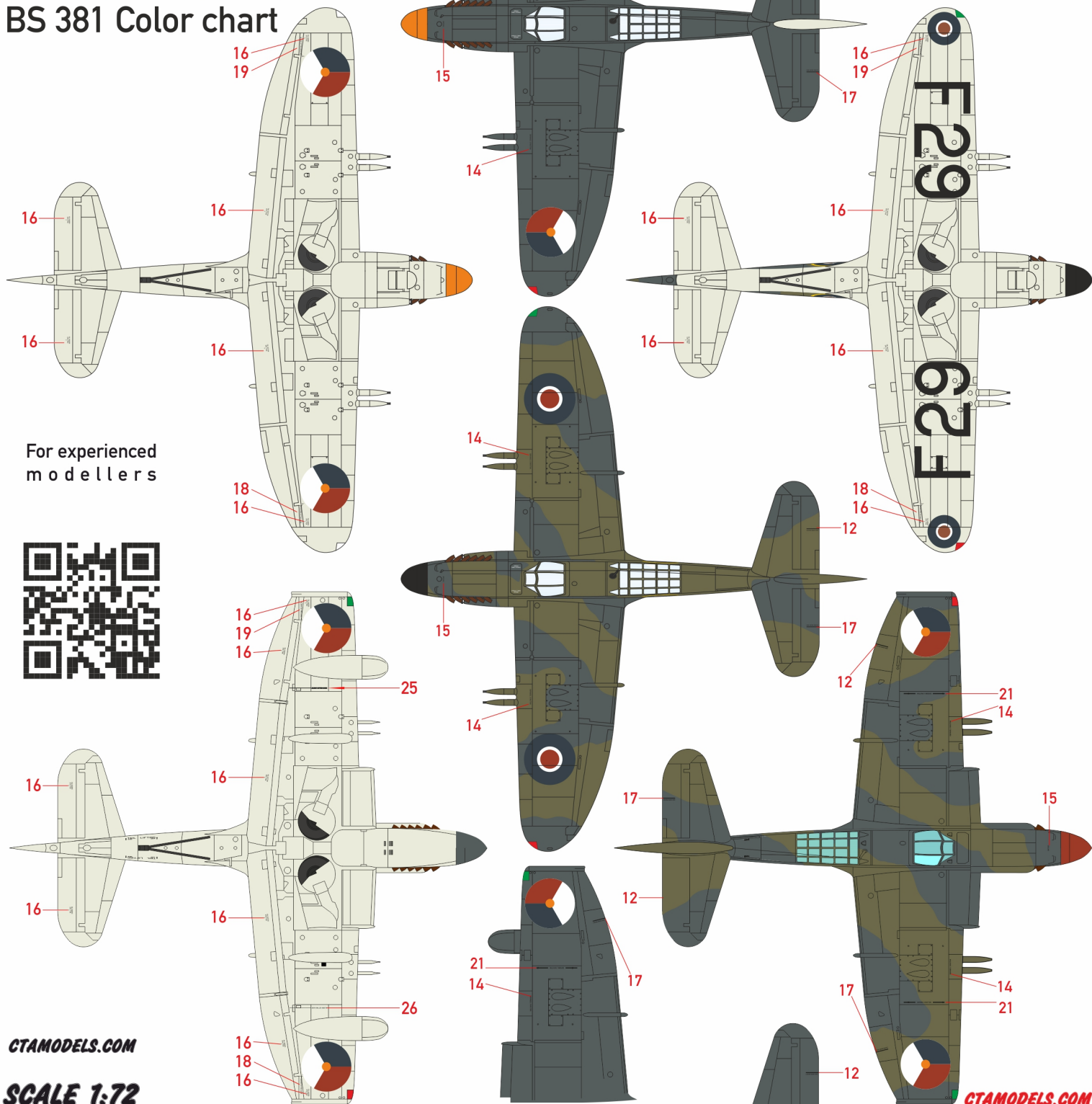







# De Vliegende Nederlanders

Marine Luchtvaartdienst Van Koninklijke Marine

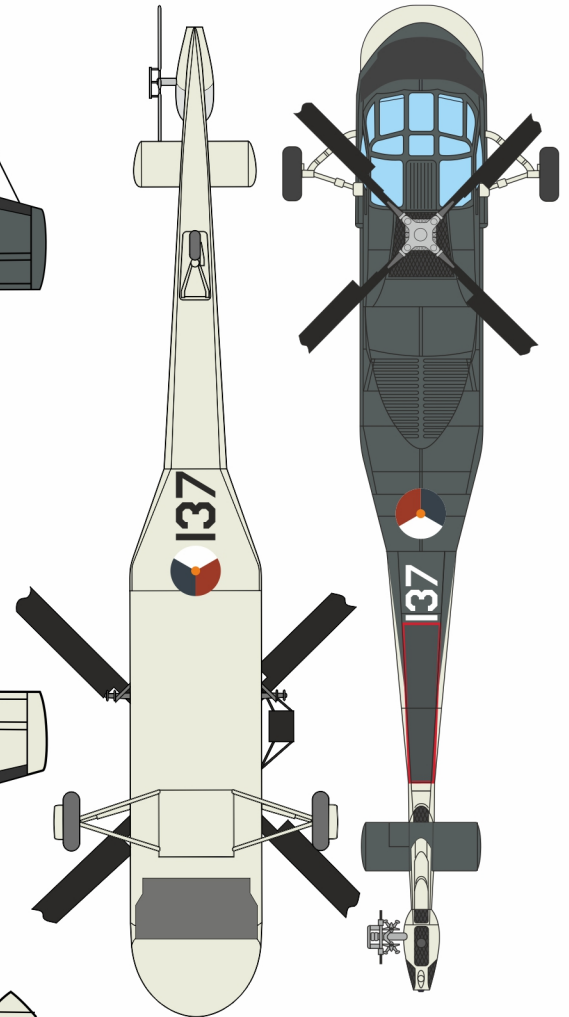
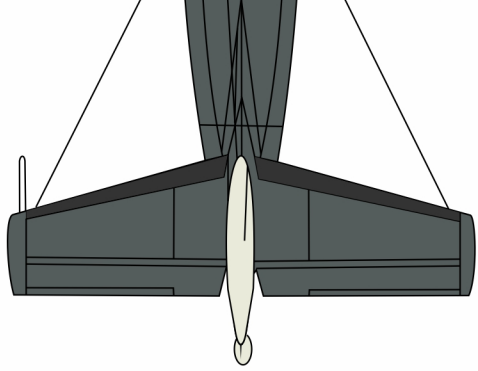
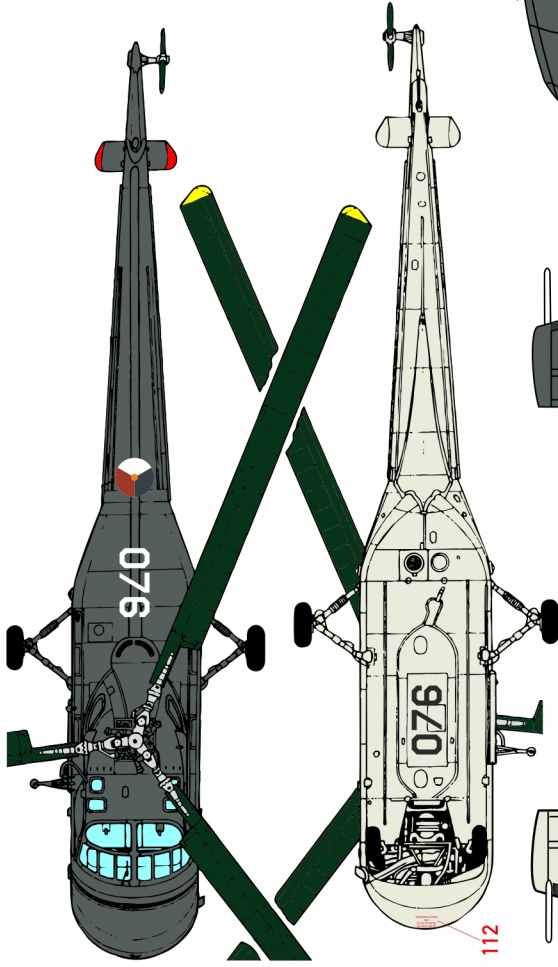
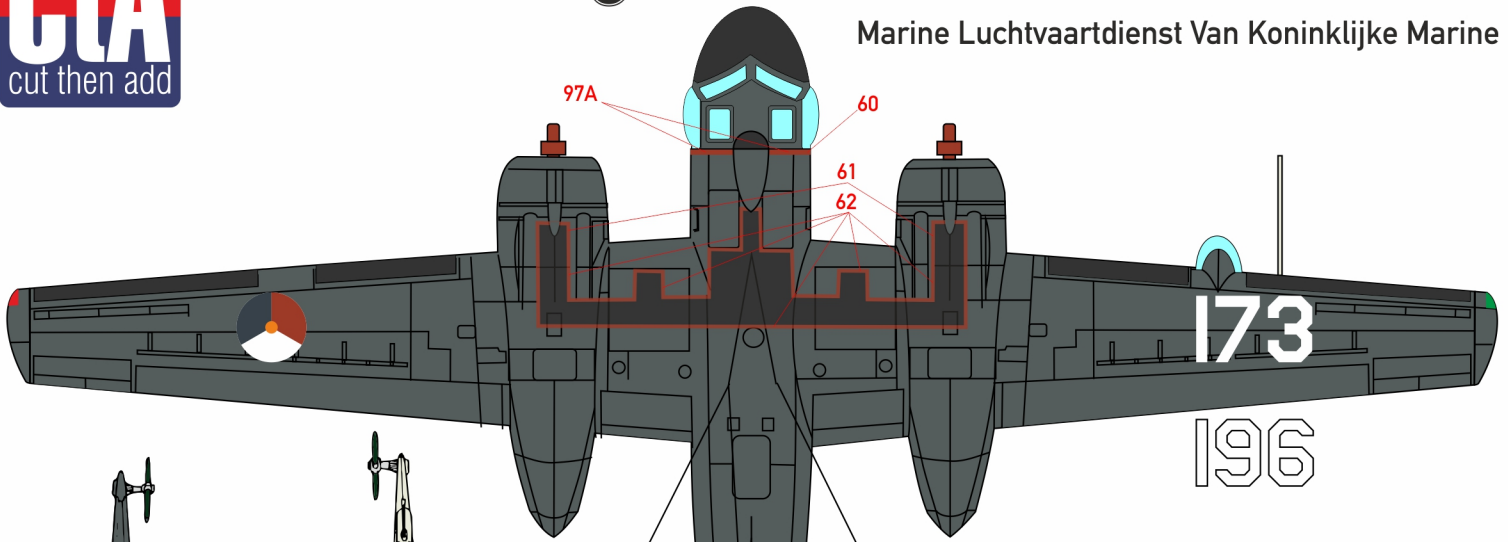

BS 381 Color chart

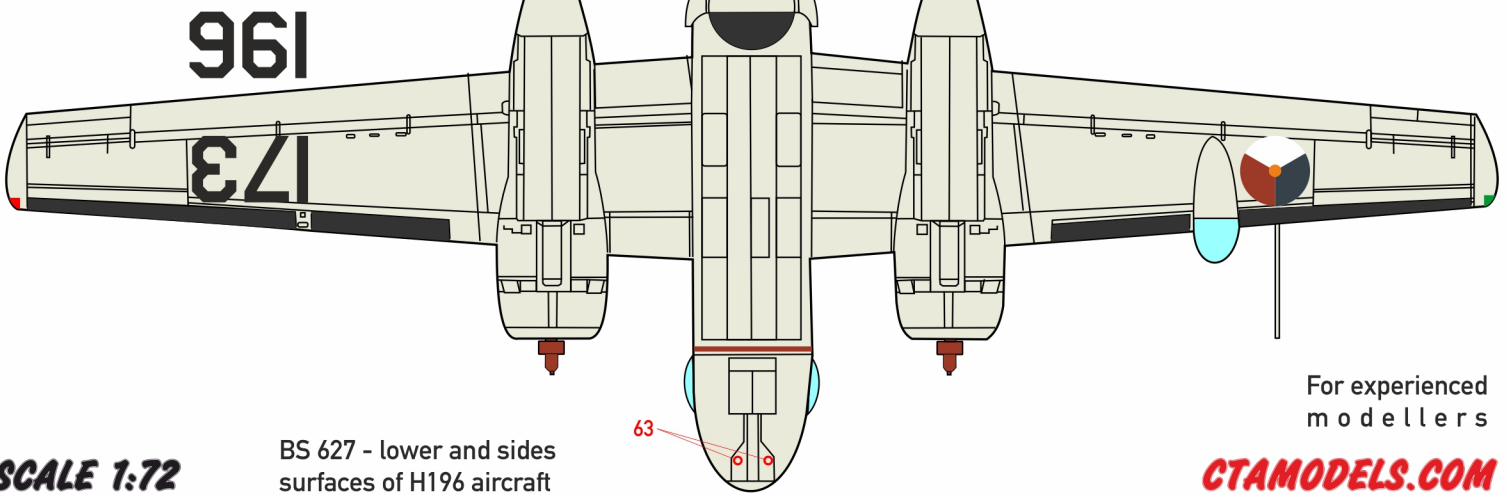

SCALE 1:72

BS 627 - lower and sides surfaces of H196 aircraft

For experienced modellers

CTAMODELS.COM