

1/48 Scale

ITEM No.:80372

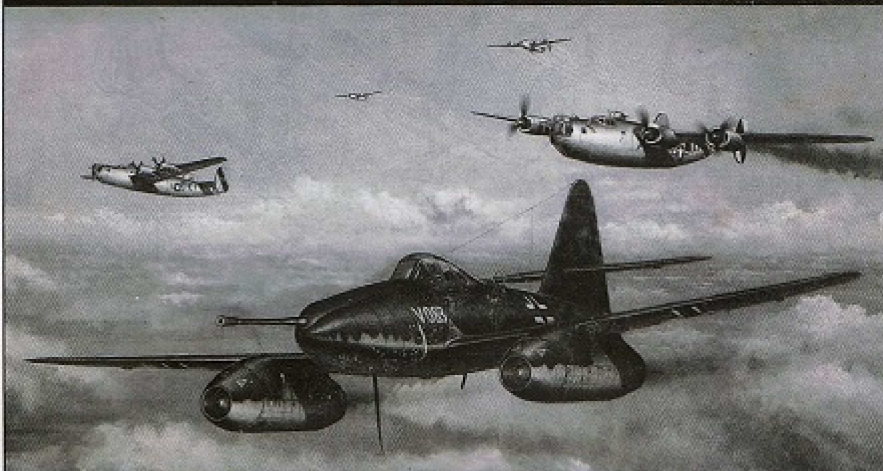

Messerschmitt Me 262 A-1a/U4

メッサーシュミット Me262A-1a/U4

德国Me 262 A-1a/U4战斗机-“大炮鸟”

PLEASE READ BEFORE OPERATION!

- * Tools recommended as below. (Not Included)
Adhesives; Paints; Side Cutters; Sharp Edged Files; Modeling Knife; Modeling File; Nippers; Drill; Sissors; Sand Paper; Soft Cloth; Cyanoacrylate Glue.
- * Make sure to read this instruction listed below before assembling.
- * The kit contains the small parts, they can be dangerous if swallowed by mistake, so keep them away from reach of children.
- * Cut the all parts off carefully and remove the waste parts into the garbage can.
- * More caution and care should be needed for cutting and handling the photo etched parts.
- * Make attention that some parts should be attached the decal when assembled.
- * During assembling, please tear up and throw away the plastic bags, or may cause the dangerous if wearing over head by children's mistake.
- * When using the adhesives and paints, please do not use them in the closed room or near the fire, also must be very careful to protect your eyes, face and clothes.
- * Adult supervised when assembled by children under 14 years old.

装配前请仔细阅读:

- * 推荐使用的模型工具(请自备):
专用模型胶水, 专用模型油漆, 水口剪刀, 长砭钳, 刀片, 锉刀, 镊子, 钻, 剪刀, 软布, 砂纸, 瞬间快干胶等。
- * 用水口剪刀或刀片小心切下所有塑胶零件和蚀刻片零件, 不要丢失小零件。
- * 切割蚀刻片时应特别注意防止利边划伤手指。
- * 用模型锉刀小心锉平所有零件表面的注射浇口。
- * 用适量的强力快干胶水粘合蚀刻片零件和金属轴, 切忌过推, 否则可能导致可动零件被粘住。
- * 注意某些零件表面需在装配时同步贴水上贴纸。
- * 制作时应远离幼儿并将包装及时收妥, 谨防小孩玩耍而引起意外。



Using CA water glue
使用强力胶



weight
称重



make hole
钻孔



cut/ remove
切胶



option
选择



no cement
不准胶水



decal
贴纸



bend
弯曲



repair
填补

The method to apply the decals

1. Cut off the decal from the decal paper and put it into the warm water 40°C for 10 seconds.
2. Take the decal from the water and put it on a piece of clean cloth.
3. Remove the decal slowly from the paper to the targeted location by a wet finger.
4. Use a piece of dry and soft cloth to press it gently on the decal until it getting dry and no bubble existing.

水贴纸的使用方法:

- 一. 把相关的印花从水贴纸上剪下, 放入40°C左右的温水中浸10秒。
- 二. 然后将印花放在干净的布上。
- 三. 拿上印花纸, 手指蘸水将印花移到适当的位置。
- 四. 用软干布轻压印花直至水干, 气泡消失。

80372

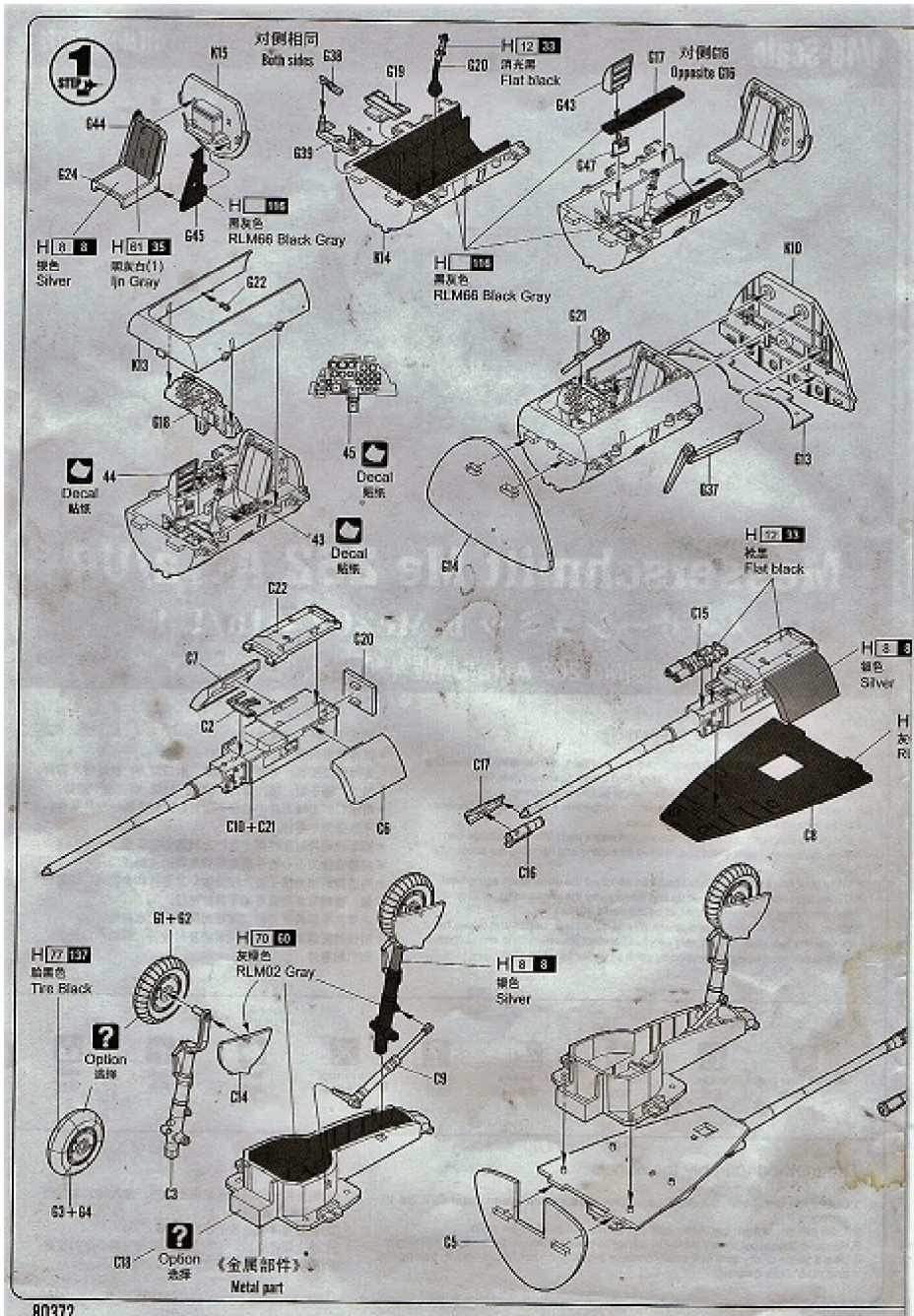

2
STEP 2

3
STEP 3

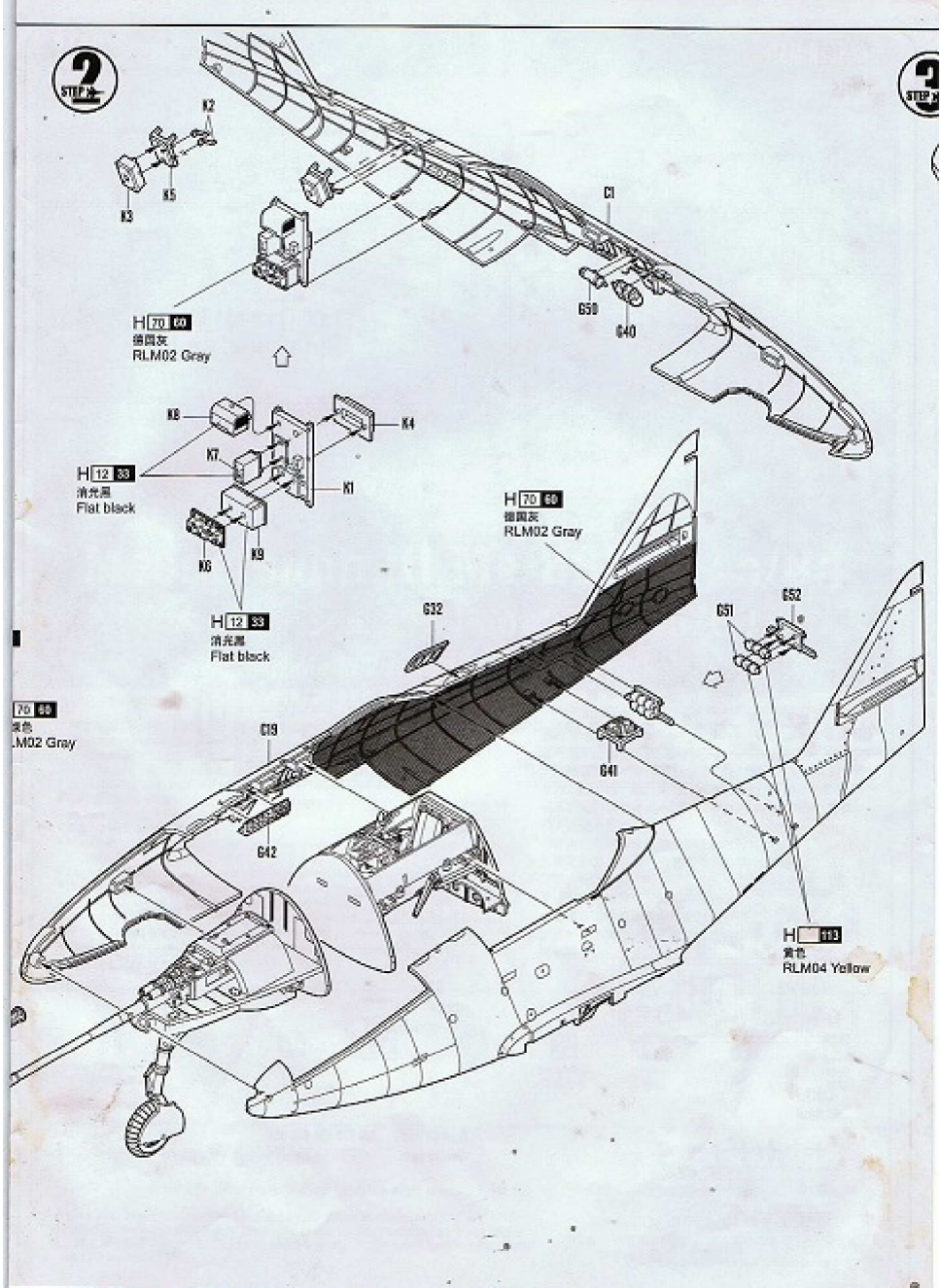

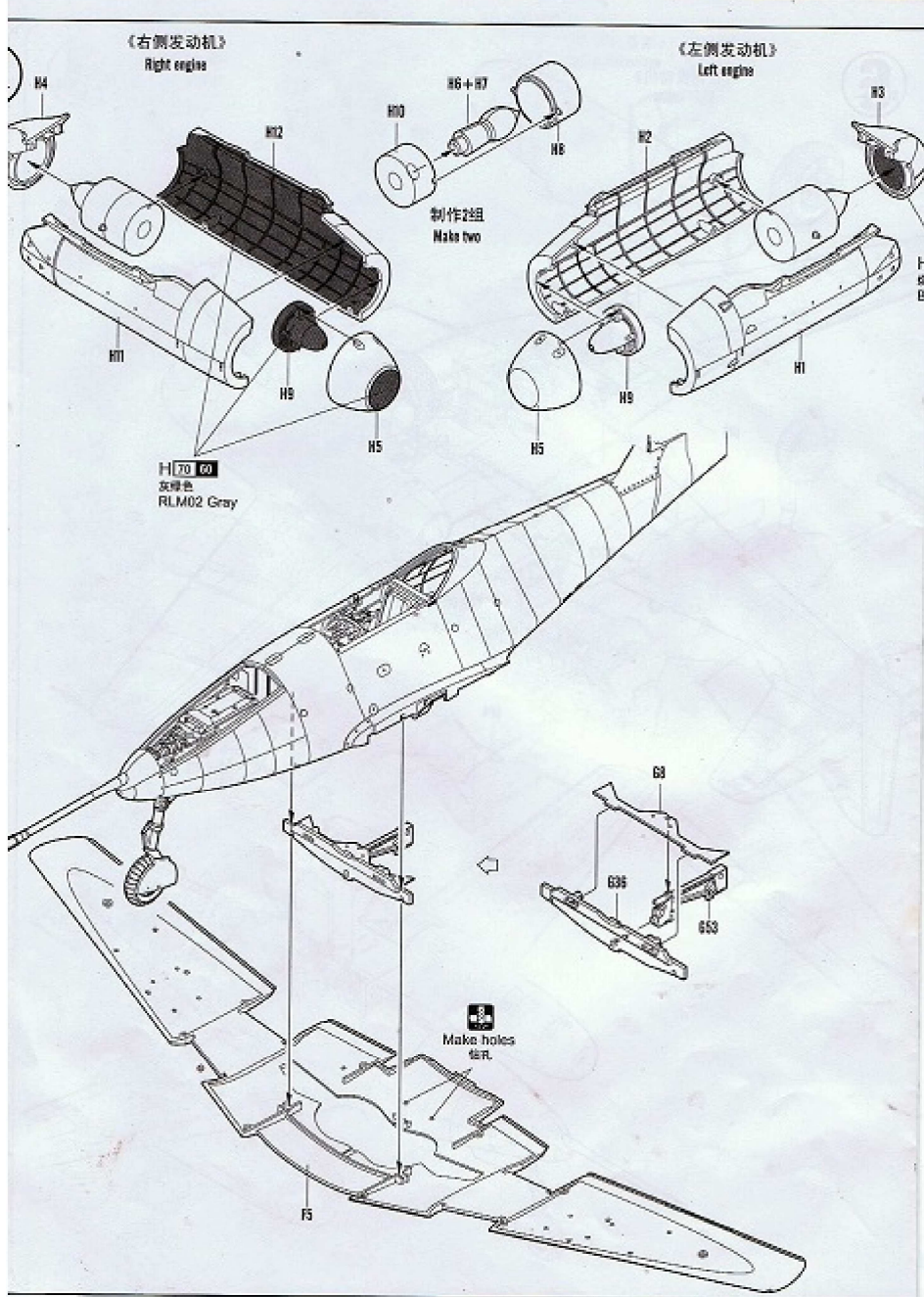

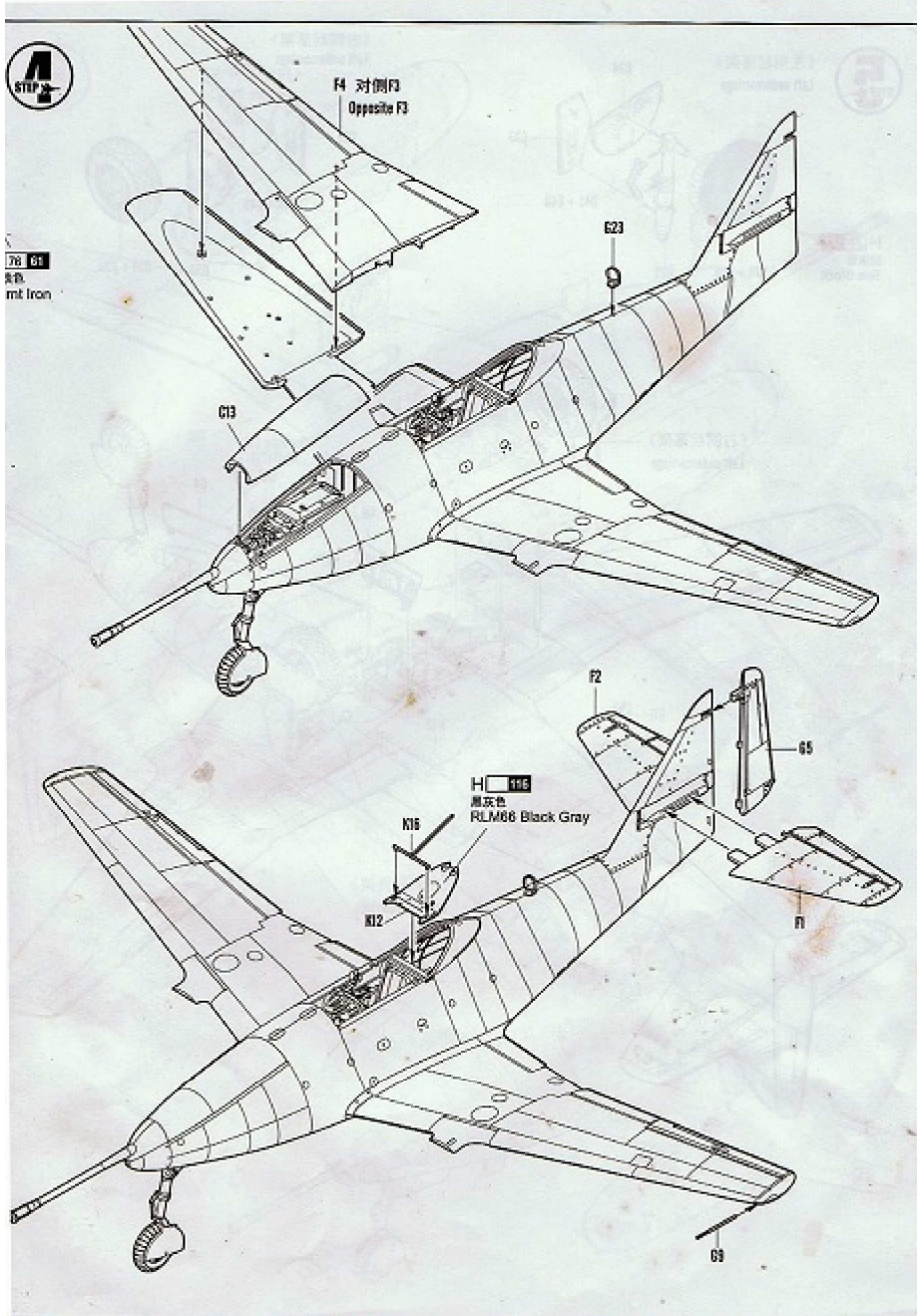

5
STEP 5

《左侧起落架》
Left undercarriage

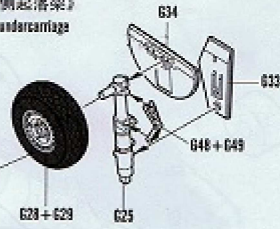

H77 137
胎黑色
Tire Block

《右侧起落架》
Left undercarriage

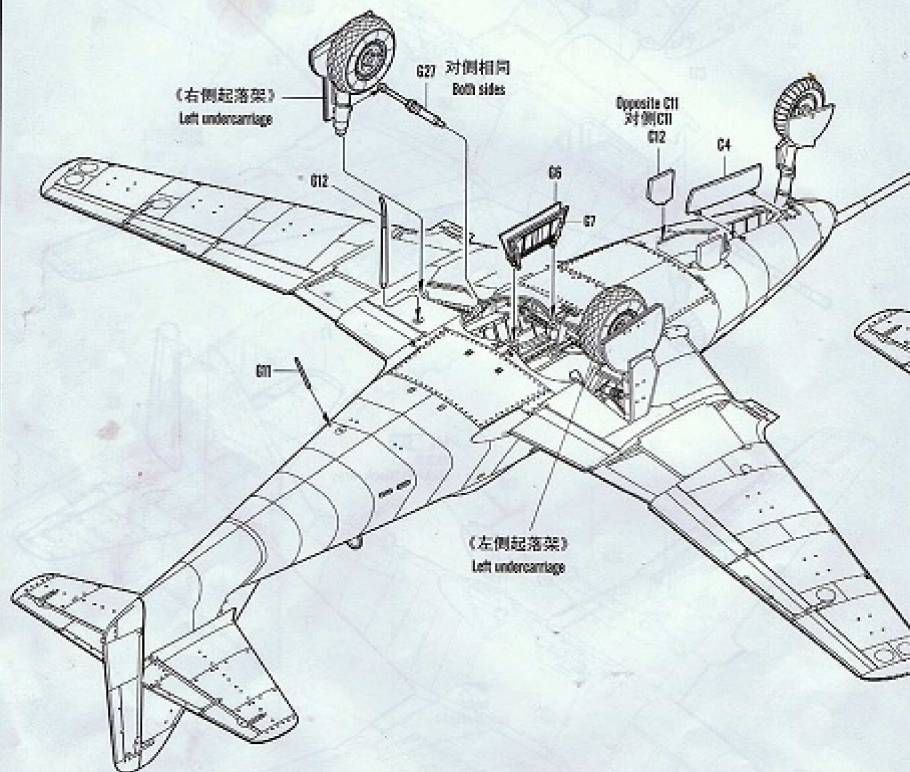
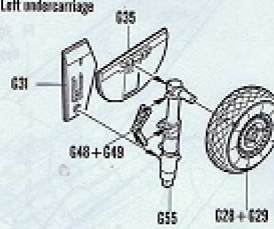

6
STEP

《右侧发动机》
Right engine

GP5

《左侧发动机》
Left engine

GP4

GP3

GP2

GP1

GP1

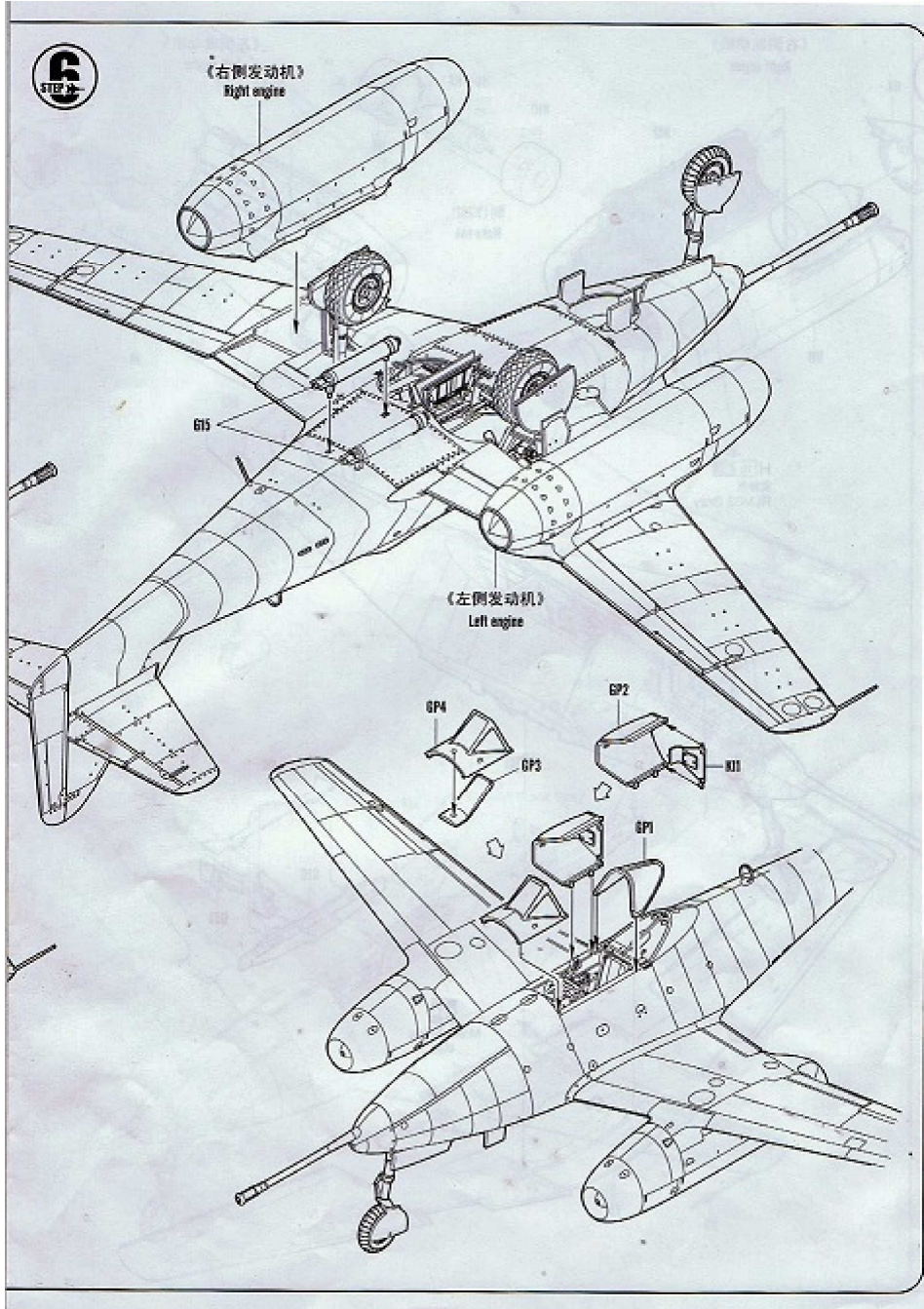

部品图
Parts

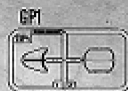
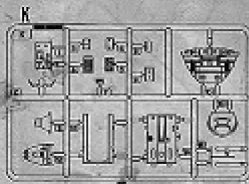
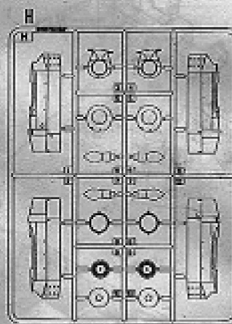
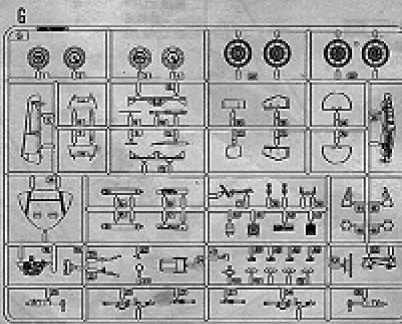
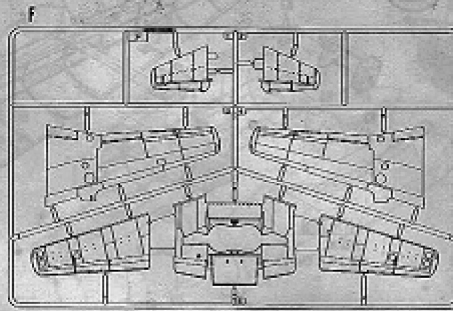
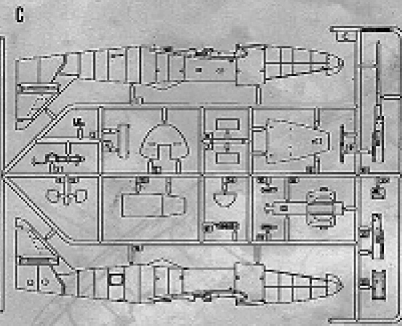

《金属部件》
Metal part

《水贴》
Decal

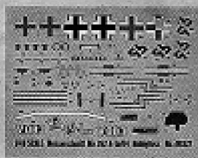

不用的部件: 010 026 030 046 054
Unused parts

标贴与涂装

Messerschmitt Me 262 A-1a/U4



MARKING & PAINTING メッサーシュミット Me262A-1a/U4 德国Me 262 A-1a/U4战斗机“大炮鸟”

Me262A-1a/U4, W.Nr.170083. "Happy Hunter II".

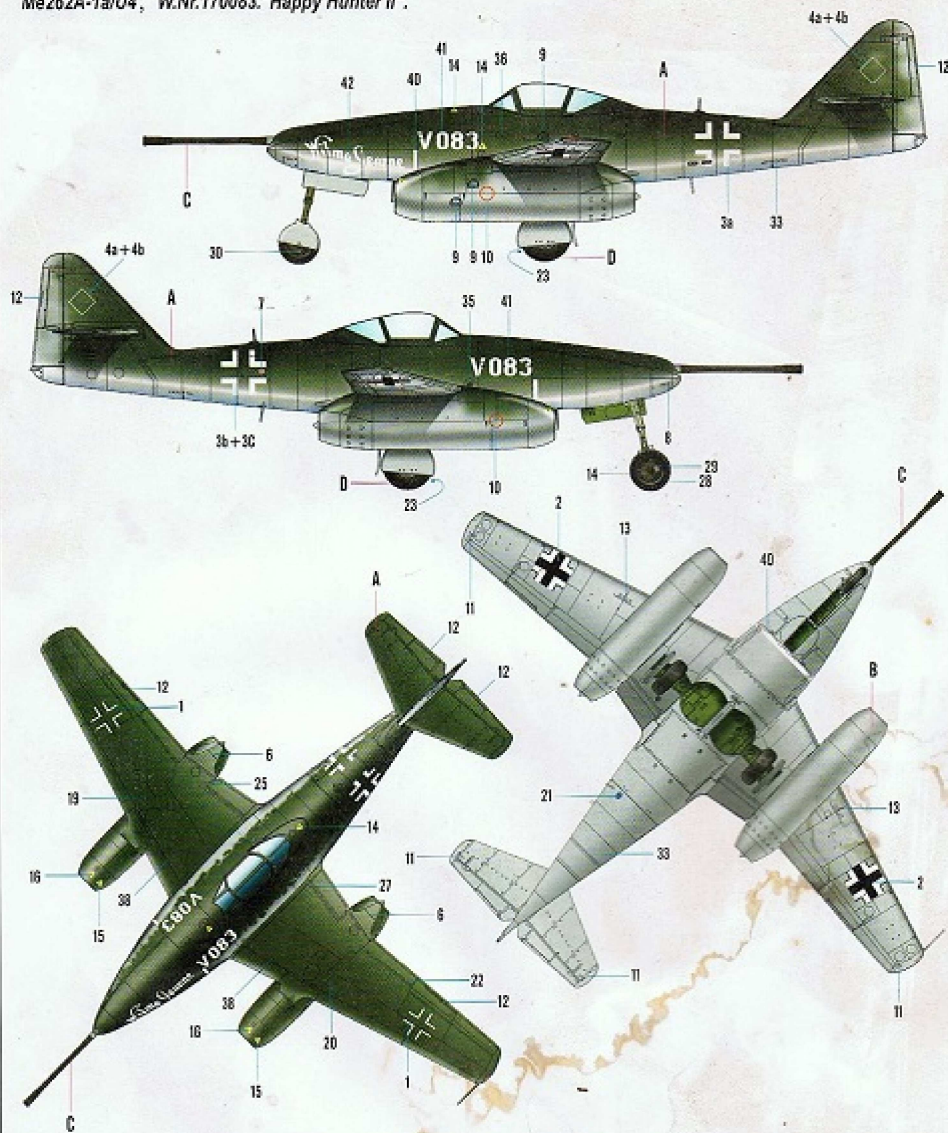

Color	Mr.Hobby	Vallejo	Model Master	Tamiya	Humbrol
A 深绿色 ALM85 Dark Green	H 125	892	--	--	--
B 浅蓝色 ALM76 Light Blue	H 117	907	1731	--	--
C 烧蚀色 Burned Iron	H 79 61	863	1785	X10	53
D 胎黑色 Tyre Black	H 77 137	--	--	--	--

NO.:80372

※ Some parts may not be available in your country. Please check your local hobby shop for substitute.