

eduard  
MASK

CX 458

# Halifax B Mk.III 1/72

The die-cut mask for accurate canopy frame painting of the  
*Revell 04936* scale 1/72 KIT

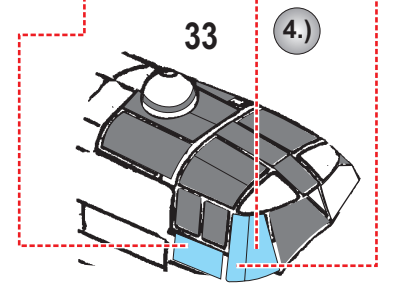
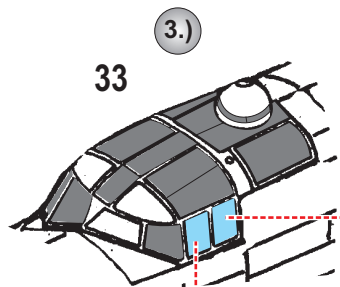
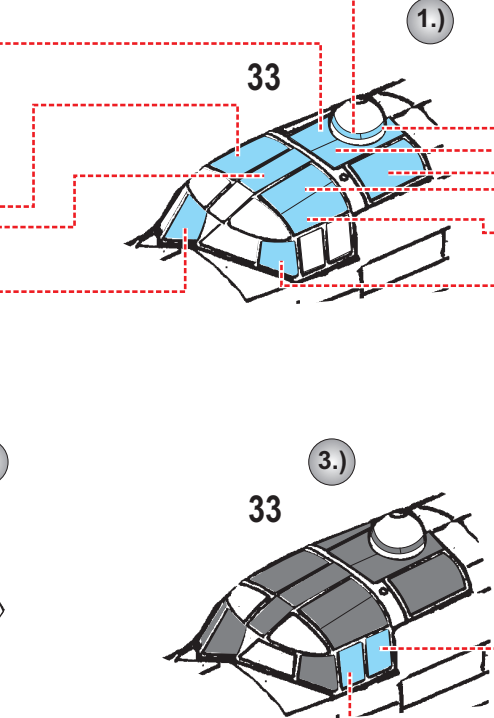
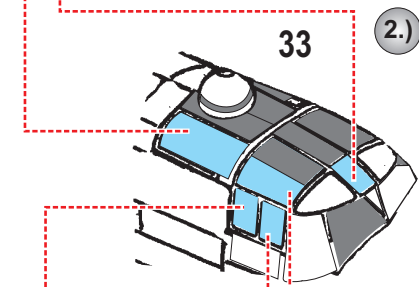
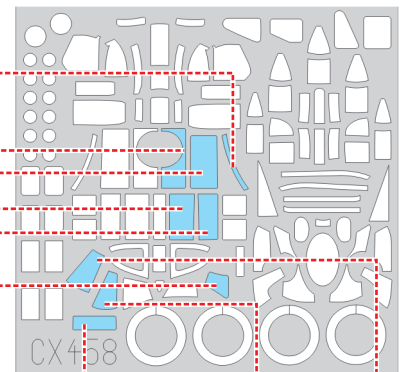
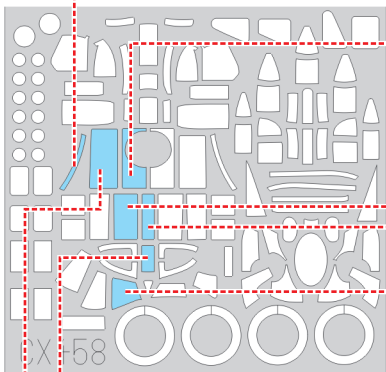
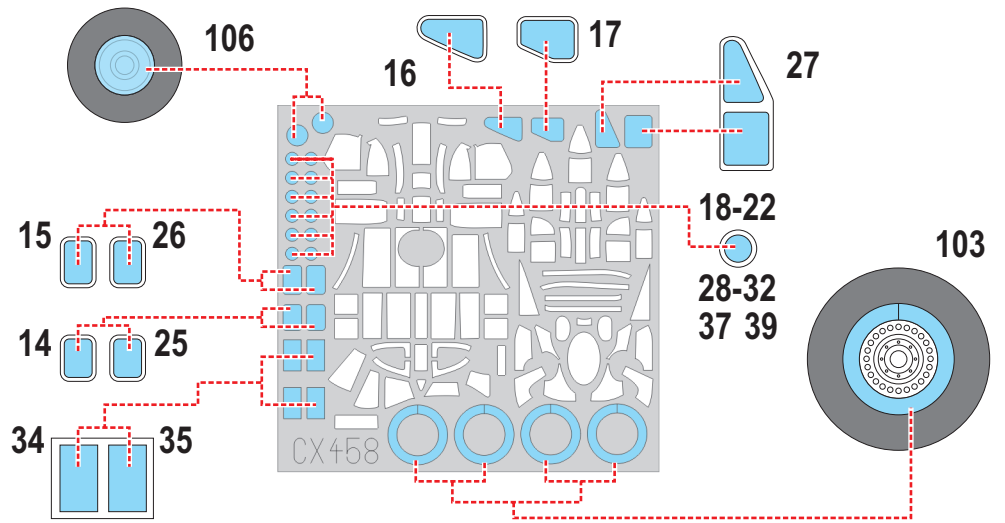
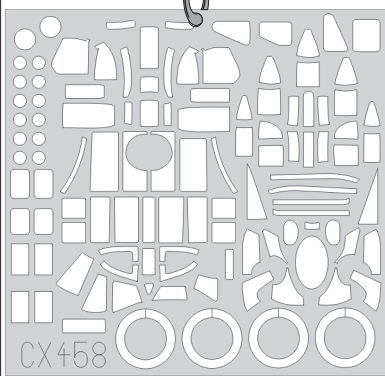

## LIQUID MASK

