

F9F-2 & XF9F-2/XF9F-3

For the Trumpeter & Hobbycraft kits

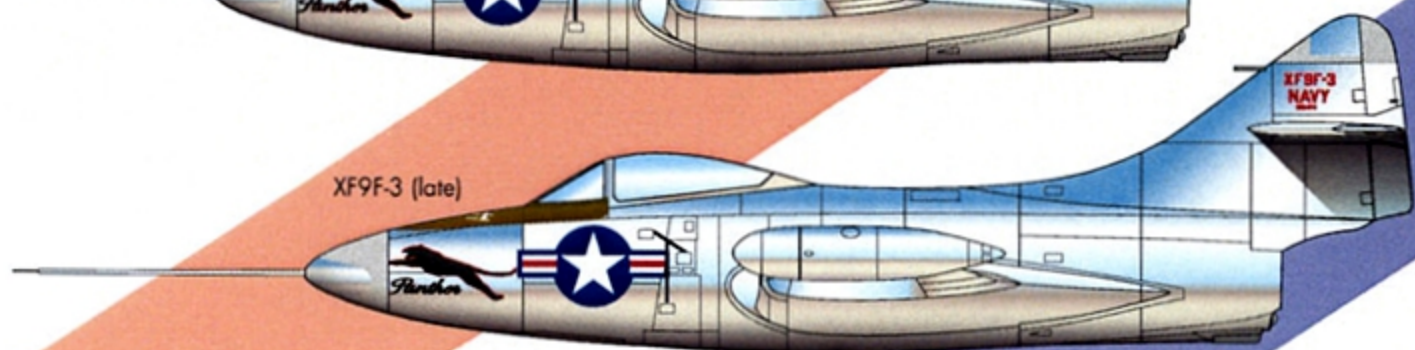
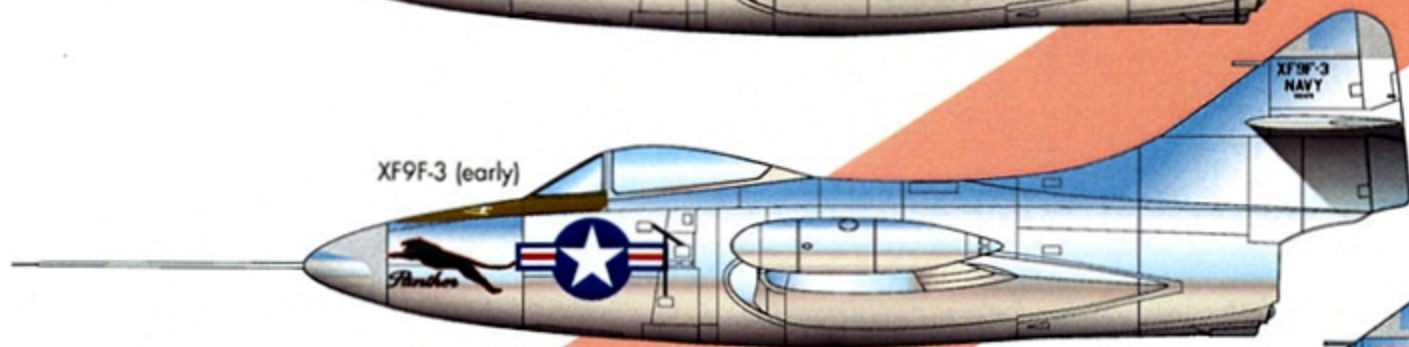
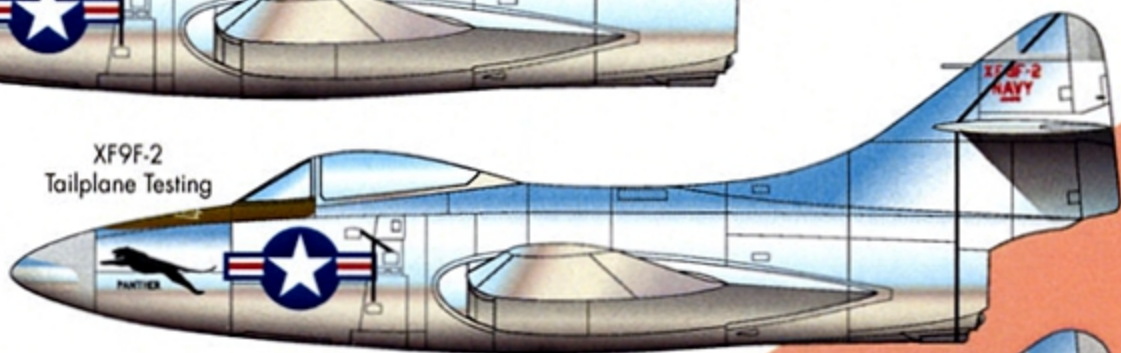
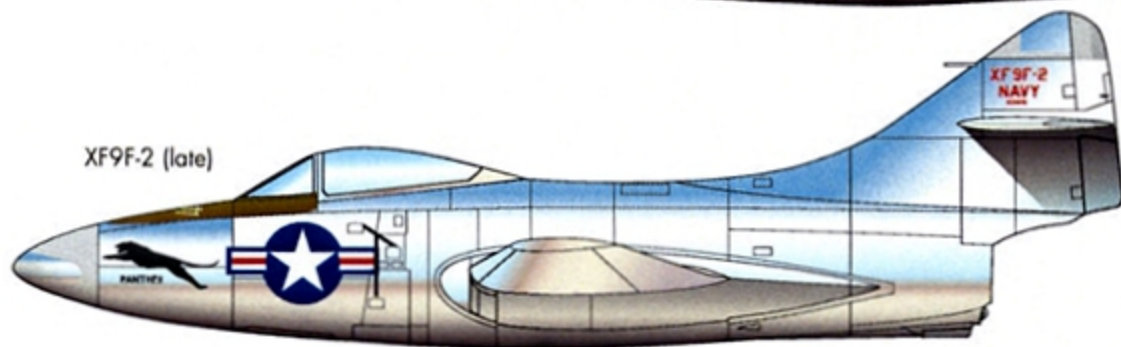
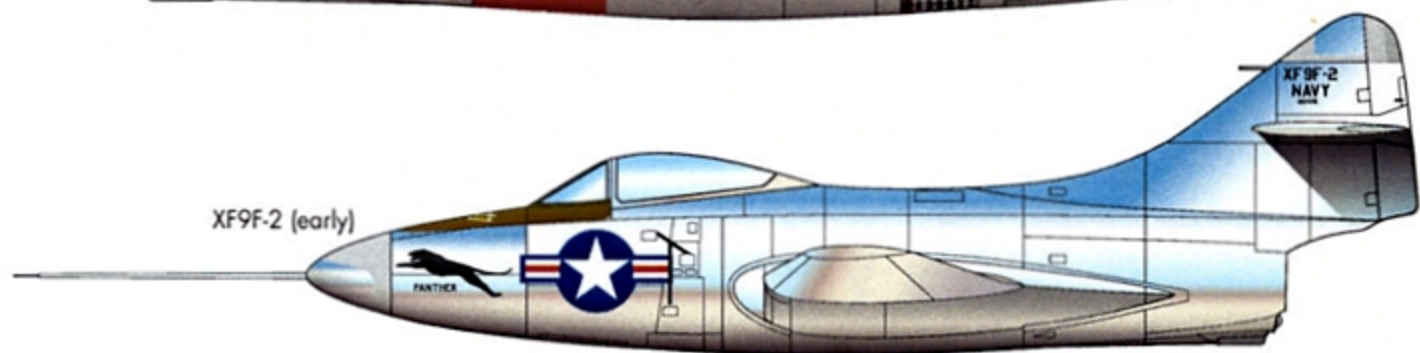
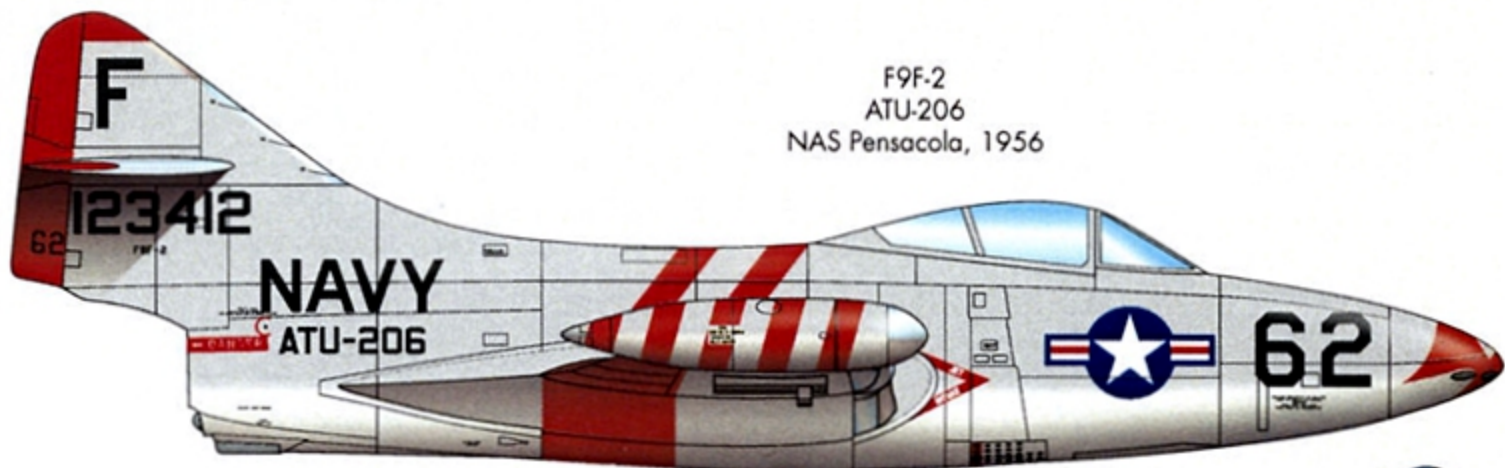

YHD48040

Hot Cats on Parade #3



Note that every aircraft from this unit exhibited significant detail differences in the overall markings scheme.

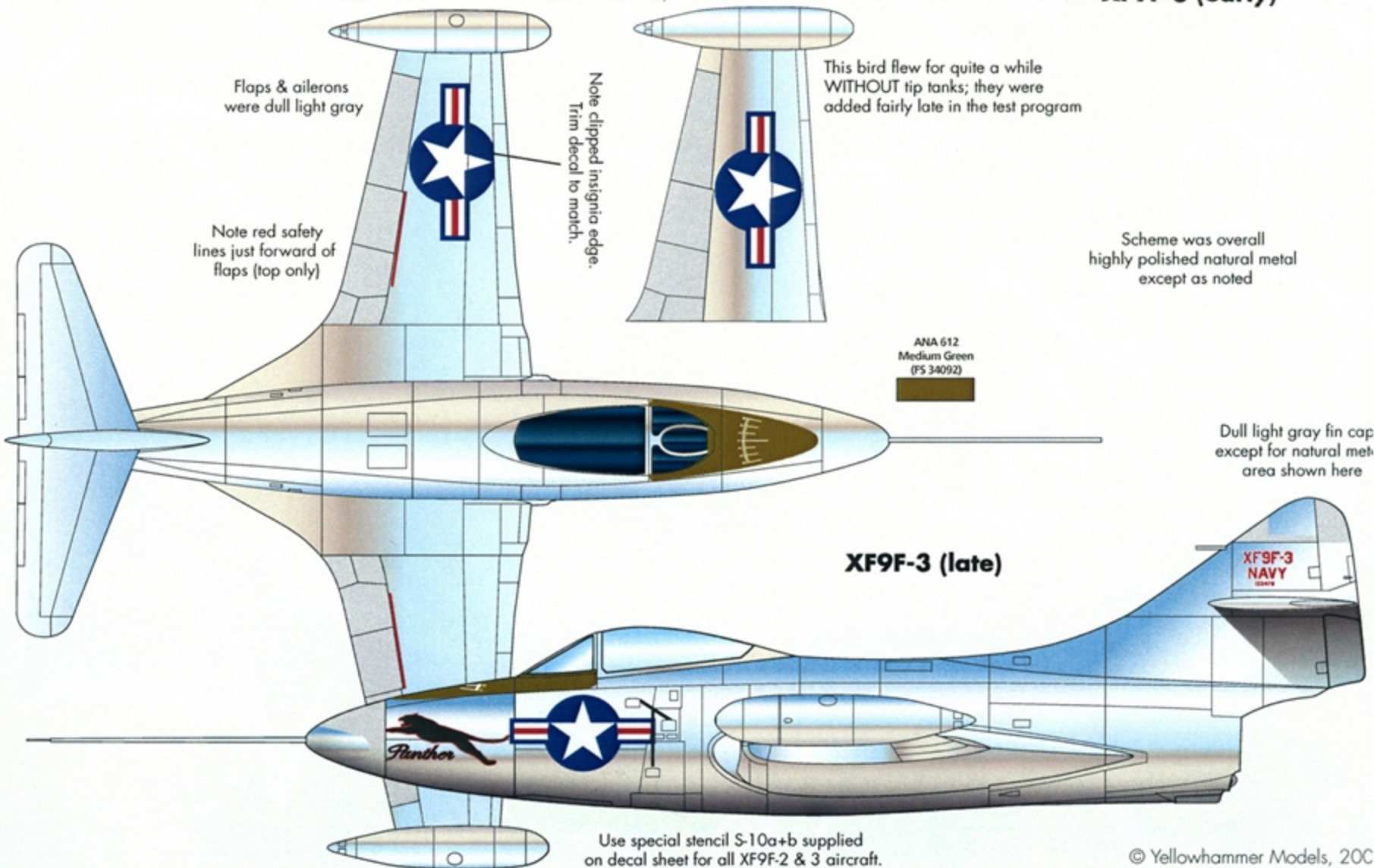
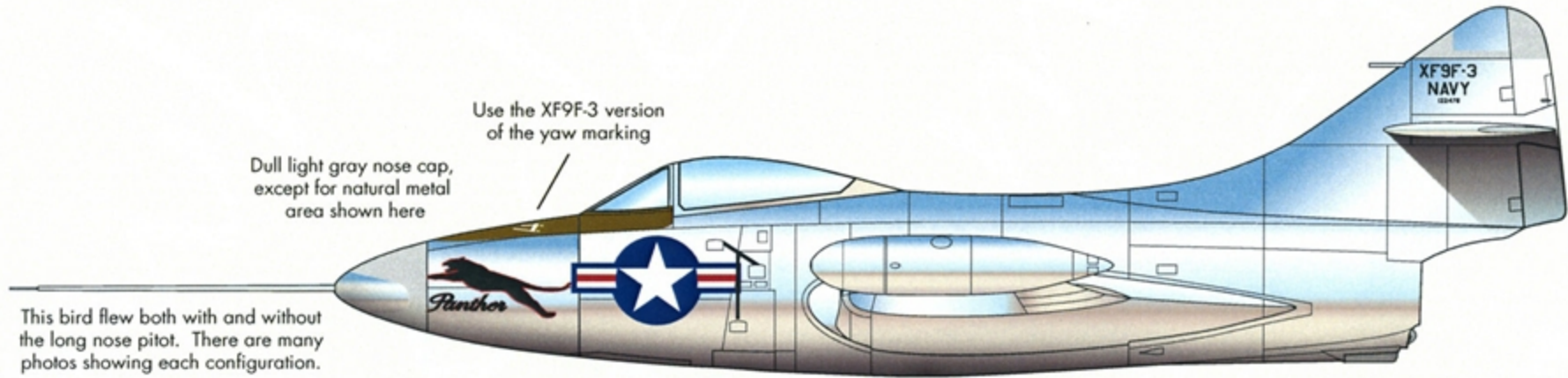

YHD48040

Hot Cats on Parade #3

XF9F-2 (early)

This bird flew both with and without the long nose pitot. There are many photos showing each configuration.

Use the XF9F-2 version of the yaw marking



The early panther & name did NOT have a white outline

Use special stencil S-10a+b supplied on decal sheet for all XF9F-2 & 3 aircraft.

Scheme was overall highly polished natural metal except as noted

NOTE: Teknics has created several useful correction/ conversion sets you may find useful.

- TK48088: XF9F-2/3 Prototype Conversion Set
 - TK48085: F9F-2/3 Corrected Outer Wings With Tip Tanks Set
 - TK48089: F9F-2/3 "Down & Dirty" Conversion Set
 - TK48086: F9F-2/3 Corrected Fighter Nose
 - TK48091: F9F-2/3 Seamless Intakes for Trumpeter/HobbyCraft.
 - TK48092: F9F-2/3 Corrected Canopy
- Check www.meteorprod.com for details.

Flaps & ailerons were dull light gray

Check your references for specific pitot tubes fitted; these varied considerably over the life of the ship

Note red safety lines just forward of flaps (top only)

ANA 612
Medium Green
(FS 34092)

XF9F-2 (late)

Dull light gray nose cap, except for natural metal area shown here

By the time the red/white tail markings were applied a white outline had been added to the panther

This bird flew for quite a while WITHOUT tip tanks; they were added fairly late in the test program

Black stripes on wing tops only



The photographic alignment stripes were applied for this test series only; they were removed after the testing was complete

Dull light gray fin cap, except for natural metal area shown here

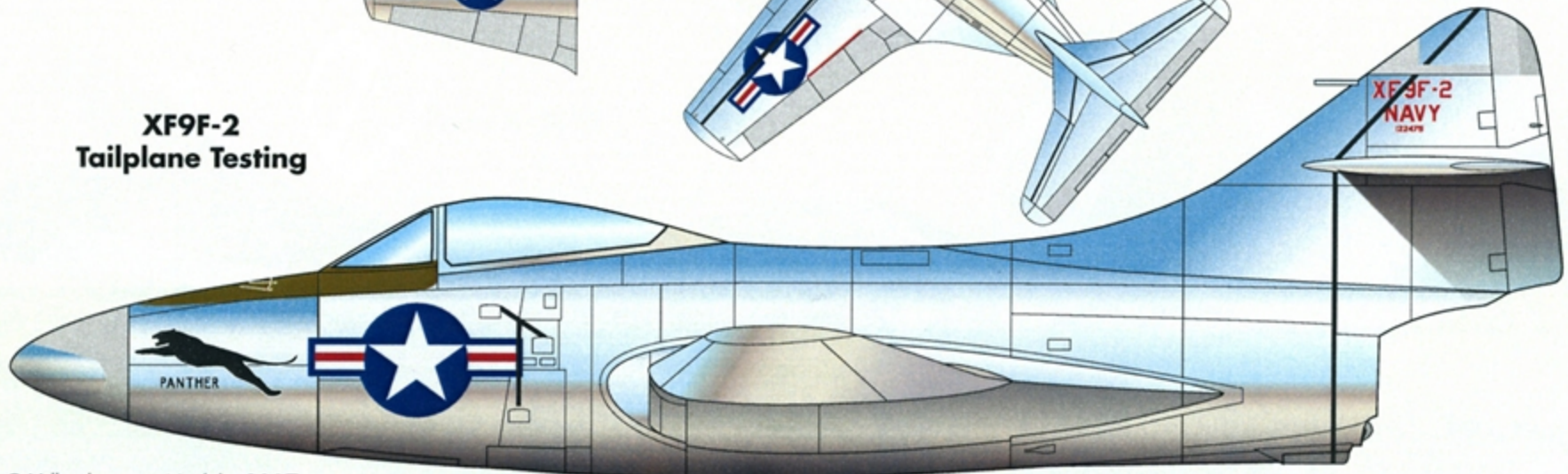
XF9F-2 Tailplane Testing

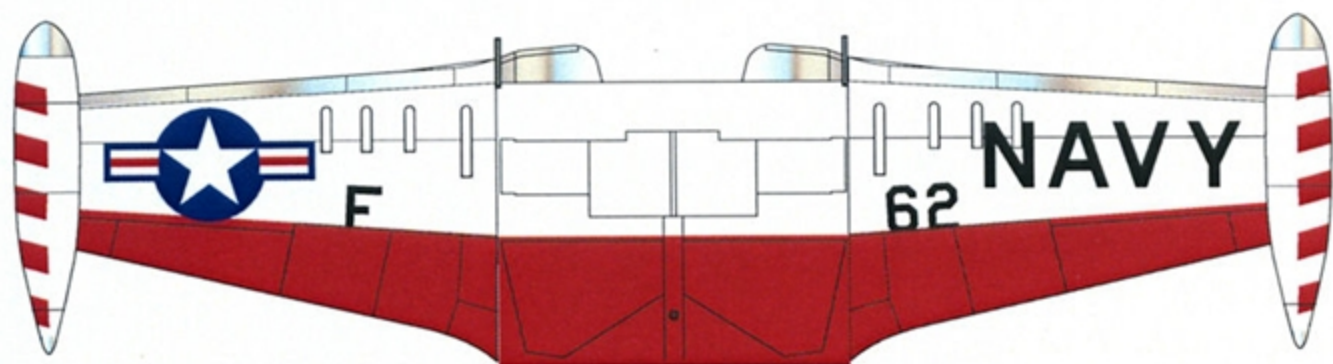



-  ANA 511 Insignia White (FS 17875)
-  ANA 620 Light Gull Gray (FS 36440)
-  ANA 509 Insignia Red (FS 11136)

Note asymmetrical differences in stripe positions on the wing tanks. Every bird was different in this unit, and many of the stripes appear to be completely hand-painted. The overwing/over-fuselage stripes were also different on every jet, and again, some appear to have been hand-painted.

Some published profiles show the red tip tank stripes painted over all-white tip tanks. In fact, they were painted directly over the Light Gull Gray/Insignia White camouflage colors, so the red stripes went over the white undersides and over the Light Gull Gray topside camouflage.

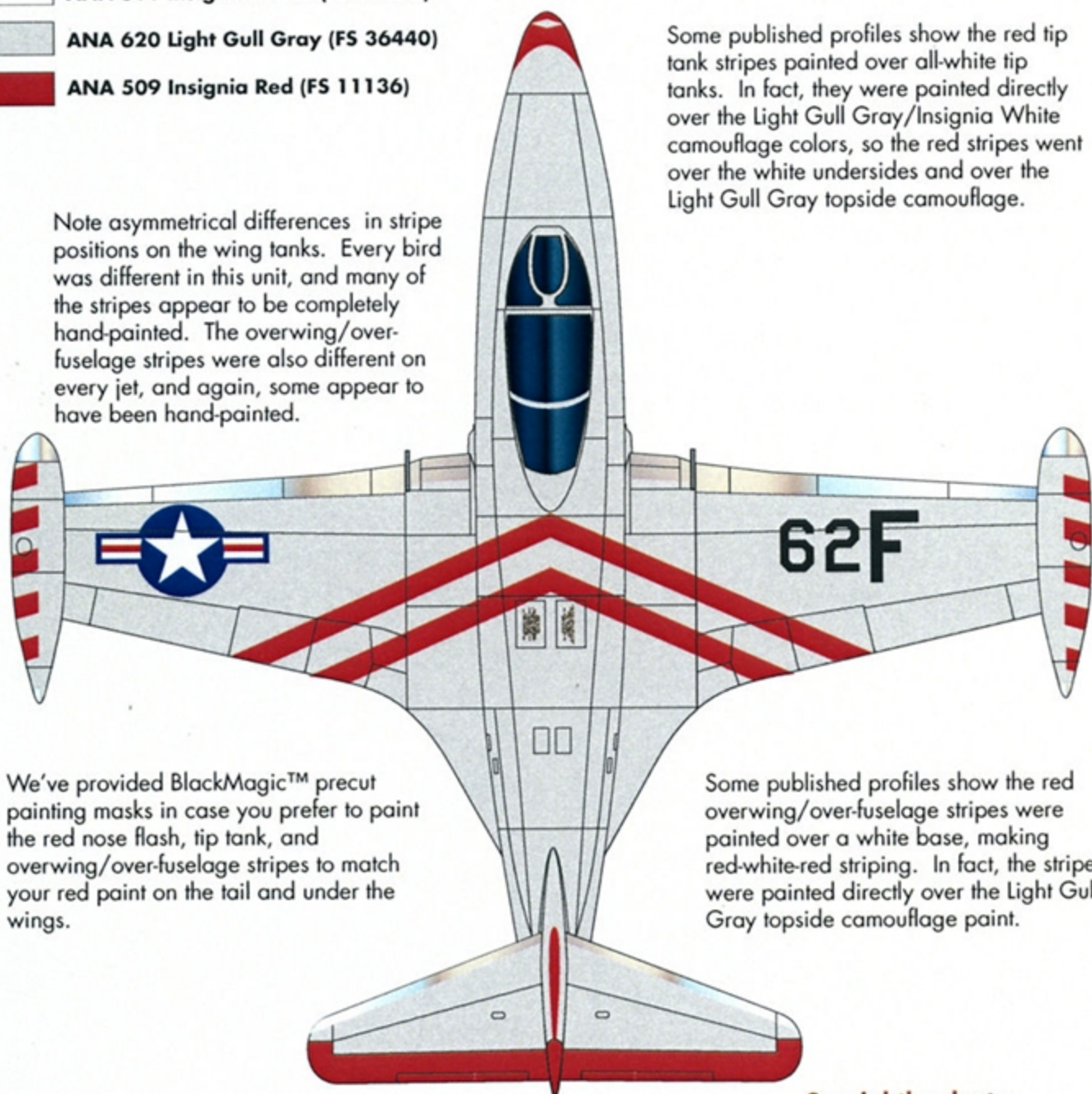

We've provided BlackMagic™ precut painting masks in case you prefer to paint the red nose flash, tip tank, and overwing/over-fuselage stripes to match your red paint on the tail and under the wings.

Some published profiles show the red overwing/over-fuselage stripes were painted over a white base, making red-white-red striping. In fact, the stripes were painted directly over the Light Gull Gray topside camouflage paint.

Special thanks to
Mike "Eagle Eyes" Lampros

...available from

Meteor

Productions
Inc.

P.O. Box 3956, Merrifield, VA 22116 USA

☎ 703/440-8720 FAX 703/440-8724

www.meteorprod.com

Write, call, or visit our home page to order our decals, kits, conversions, tools, books, magazines, etc., and we'll send it to you right away!

© Yellowhammer Models, 2007

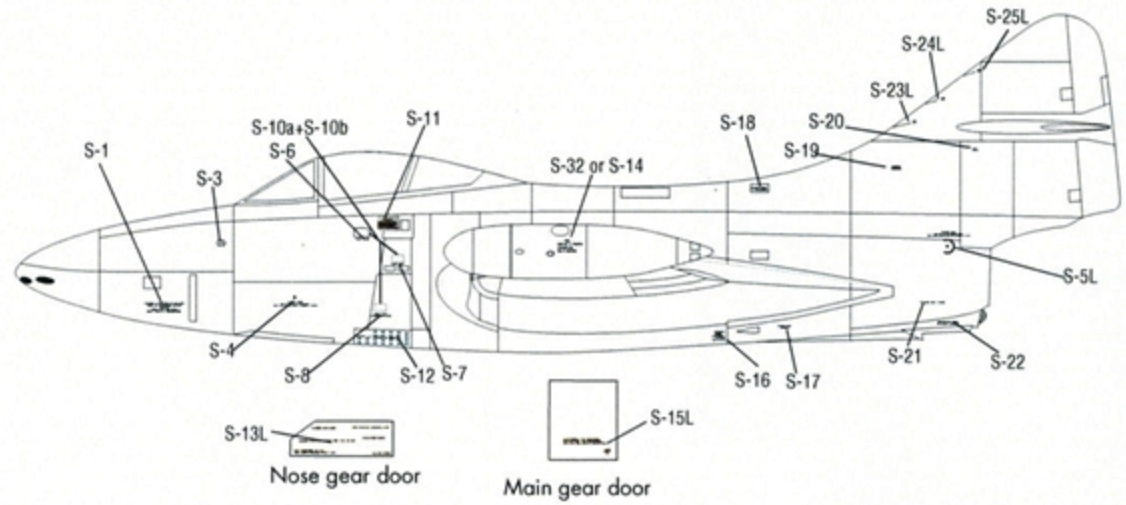
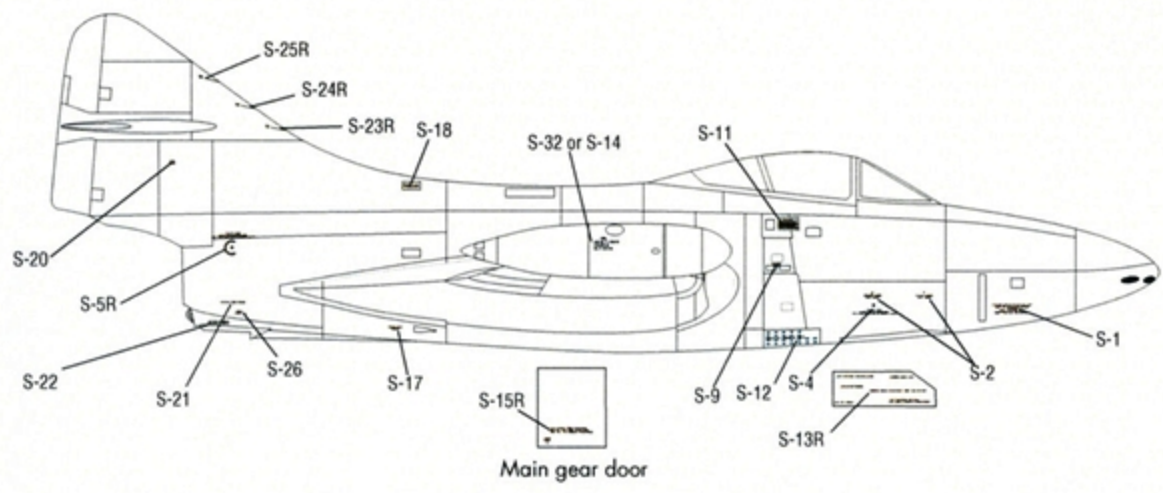

1/48 templates for upper blow in doors

