

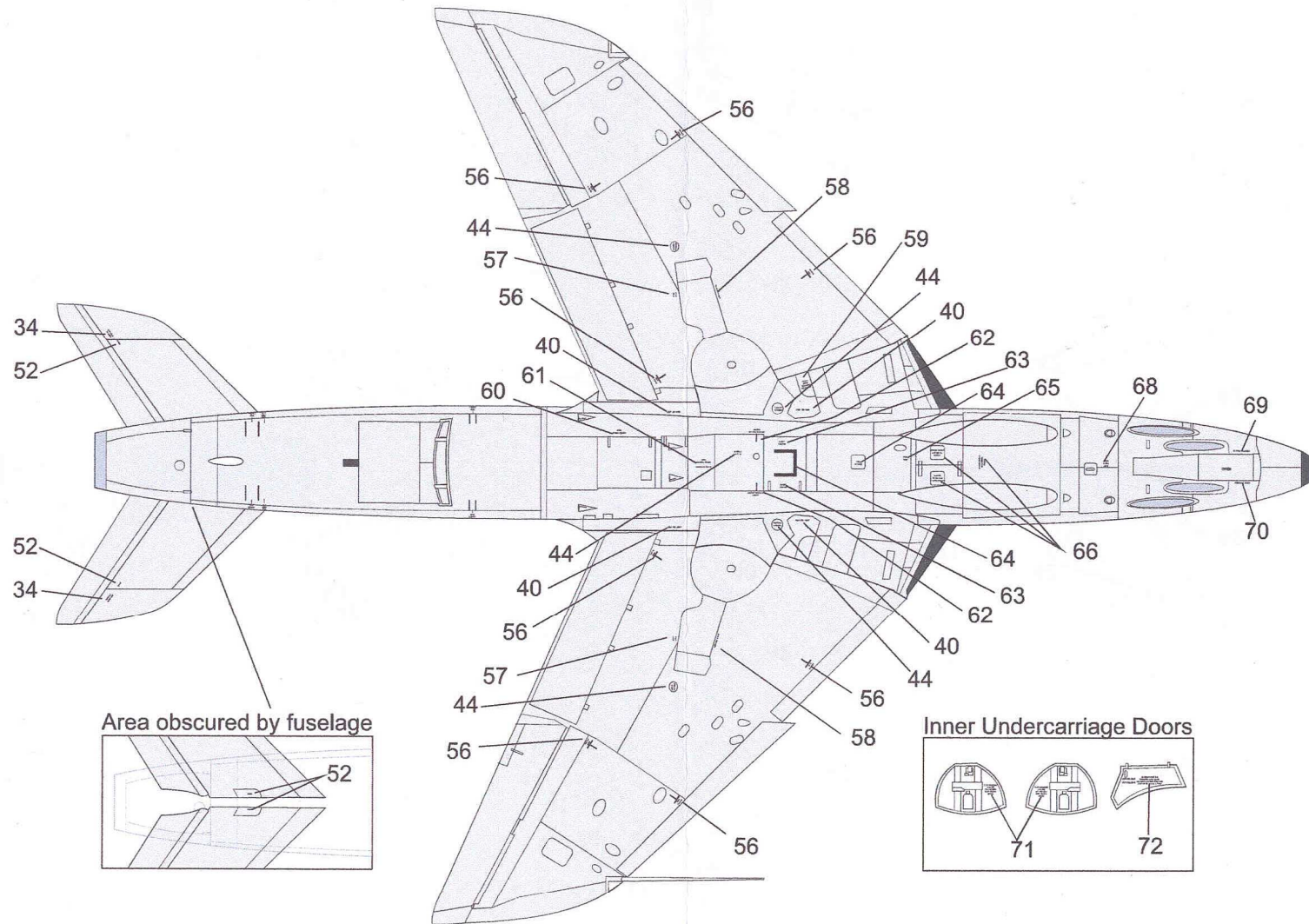

Intentionally Blank

# Hawker Hunter

## STENCIL PLACEMENT



# Hawker Hunter

## STENCIL PLACEMENT

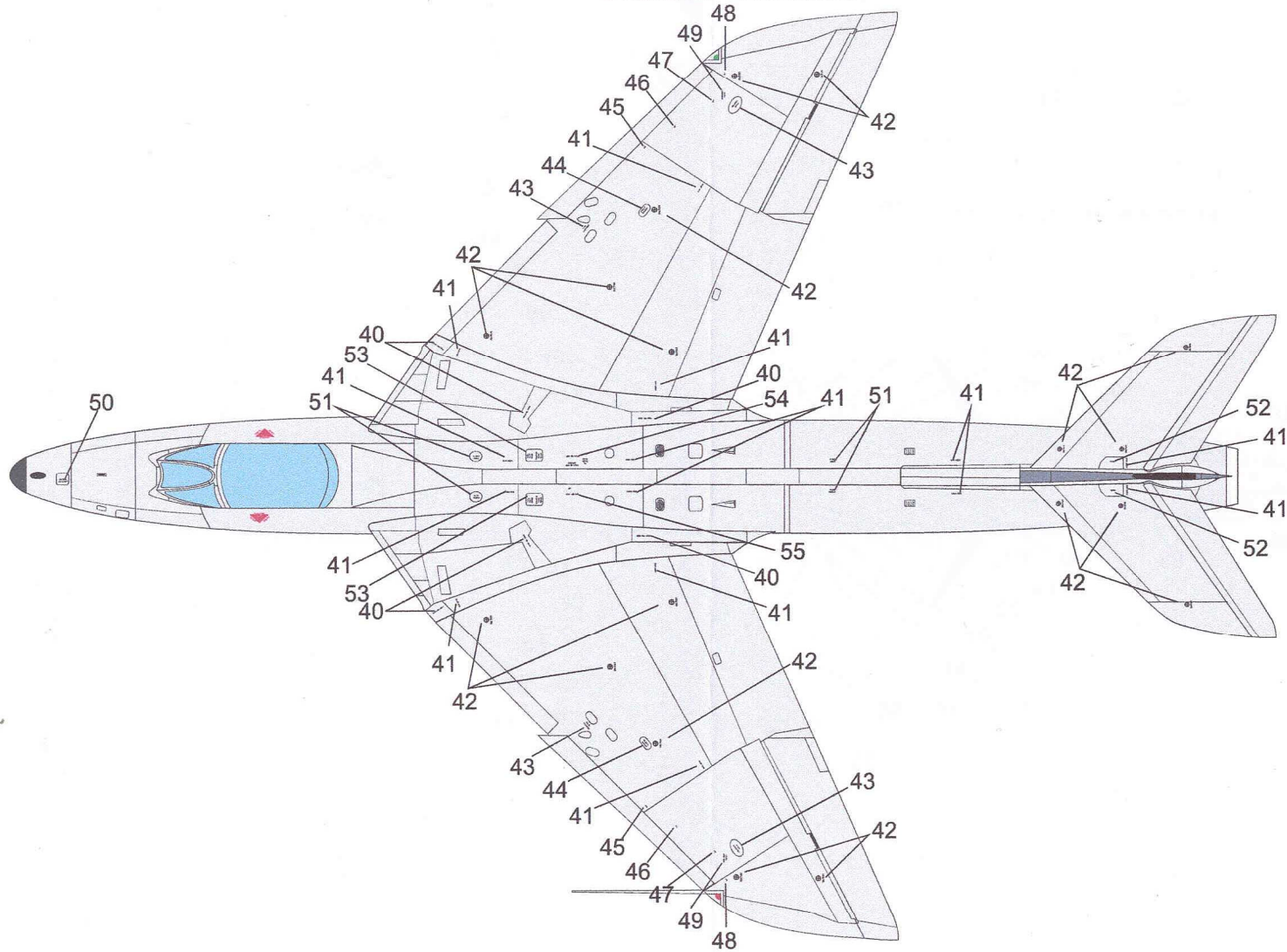

# Hawker Hunter

## STENCIL PLACEMENT

2 part decal start from lower edges, join at top 82

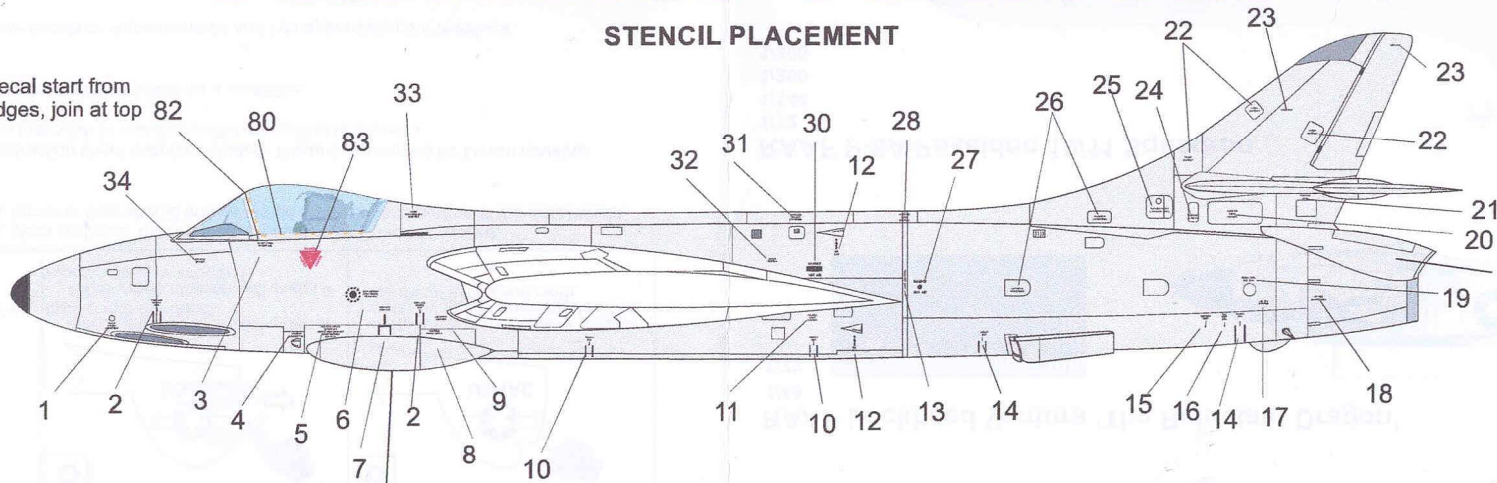

Shown with brake parachute housing (Mk 9 and later)

Shown with ammunition link collector (port and stbd) (Mk.4 and later)

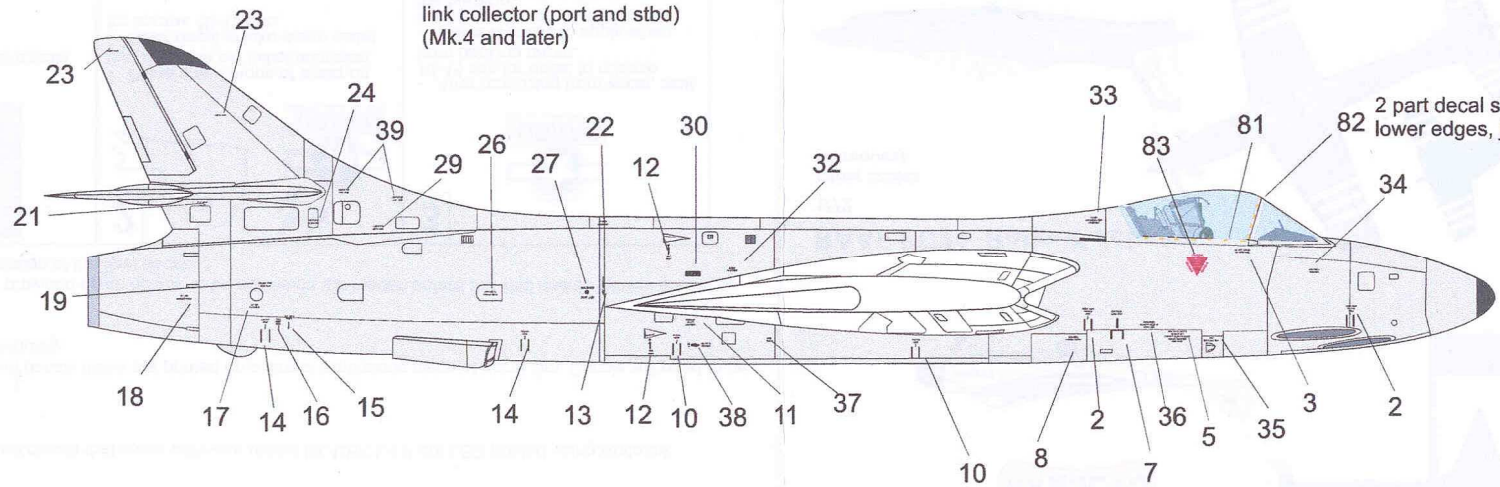

2 part decal start from lower edges, join at top 82

### 100 Gallon Underwing Tank

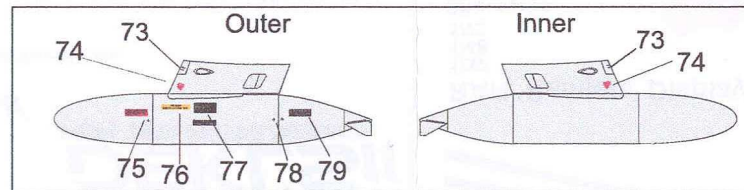

Options are provided for stencils in various colours, to accommodate different schemes

USING **DEKLS II**

**Thank You**

Thank you for your purchase of these expertly produced, high quality, short print run decals.

**CAUTION: HANDLE WITH CARE**

To keep the thickness of the decal to a minimum, it has not been coated. Do not place anything on the face of the decal that may scratch it (ie model kit / tools/ etc).

**They are a little different!**





Unlike the commercially produced decals that come with your model kit, DEK L's II are LED printed using white ink technology.

**Removal from the sheet**

As with most short production run decals these are printed on a single continuous piece of decal film. Decals will need to be carefully cut from the sheet individually.

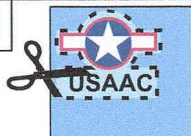
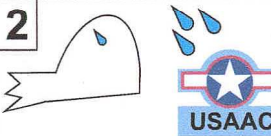
**Whites**

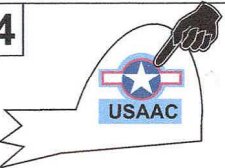
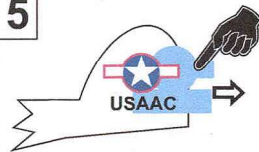
Where appropriate, 'whites' are provided as an option, to be placed on the model, before the final decal. Whites should be left to properly set prior to application of the final decal.

<p><b>1</b></p>  <p>- Carefully cut individual decals from the sheet.</p>	<p><b>2</b></p>  <p>- Place a few drops of water on the model to aid initial adhesion. - Soak decal in luke warm water for approx 10-15 sec.</p>	<p><b>3</b></p>  <p>- After removing from water, wait 10-15 sec for decal to release from backing paper. - Decal is ready to apply when transparency can be moved on the backing</p>
<p><b>4</b></p>  <p>- Position over the spot that you want the decal.</p>	<p><b>5</b></p>  <p>- Gently slide away backing paper from under the decal. - A few drops of water will assist if repositioning is required.</p>	<p><b>6</b></p>  <p>- Remove air bubbles or excess water by gently pressing down on the decal with a soft cloth.</p>

- Decals adhere best to non porous, gloss surfaces. Use on matt surfaces is NOT recommended.
- Solvents and setters may be used, however they should first be tested on an unused portion of the decal sheet.

**Extra Decals**

Additional decals not detailed on the instruction sheet may be included. These are provided for known marking variations on specific aircraft. Modellers may wish to use these after consulting references.

Replacement or additional individual decals can be provided for a small fee.















**Suggestions or Improvements**

I am always open to suggestions for new decals or improvements and I do appreciate your feedback.

Thank You!!

*Derek*

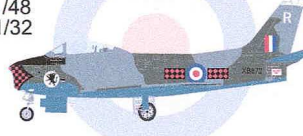
[www.dekls.com.au](http://www.dekls.com.au)  
[stores.ebay.com.au/DEK-LS-HOBBY](http://stores.ebay.com.au/DEK-LS-HOBBY)  
[www.facebook.com/deklsdecals/](http://www.facebook.com/deklsdecals/)  
[sales@dekls.com.au](mailto:sales@dekls.com.au)

<p><i>Blue Devils</i> TEAM AIRCRAFT AM 159</p> <p>1/144 1/72 1/48</p> 	<p><i>Blue Devils</i> TEAM LEADERS AIRCRAFT AM 180</p> <p>1/144 1/72 1/48 1/32</p> 	<p><i>TIGERS</i></p> <p>1/144 1/72 1/48 1/32</p> 
<p>SKY LANCERS PRE 1956 AS 226</p> <p>1/144 1/72 1/48 1/32</p> 	<p><i>Sky Lancers</i> POST 1956</p> <p>1/144 1/72 1/48</p> 	<p><i>Cruz Del Sur</i> C-113</p> <p>1/144 1/72 1/48</p> 
<p><i>Patrulla Ascua</i> FLAME SCHEME 1-099</p> <p>1/144 1/72 1/48</p> 	<p><i>Patrulla Ascua</i> FINAL SCHEME 1-254</p> <p>1/144 1/72 1/48</p> 	<p><i>SPIRIT '78</i> AVON SABRE TS-8603</p> <p>1/144 1/72 1/48</p> 
<p><i>'Silver Fox' Squadron</i> S/L LINDY MACKENZIE BT 150</p> <p>1/144 1/72 1/48 1/32</p> 	<p><i>441 'Silver Fox' Squadron</i> BT 152</p> <p>1/144 1/72 1/48 1/32</p> 	<p><i>Lancers</i></p> <p>1/144 1/72 1/48 1/32</p> 
<p><i>Golden Arrows</i> X8902</p> <p>1/144 1/72 1/48 1/32</p> 	<p><i>234 SQUADRON</i> X8972</p> <p>1/144 1/72 1/48 1/32</p> 	<p><i>RED DIAMONDS</i> X8902</p> <p>1/48 1/32</p> 
<p><i>FIREBALLS</i></p> <p>1/144 1/72</p> <p>DECALS FOR ALL 4 TEAM AIRCRAFT</p> <p>415 AP 412 BB 415 BR 434</p> 		<p>RAAF 2 TEAM SET <i>BLACK PANTHERS</i> X8902</p> <p>1/144 1/72</p> <p><i>Marksman</i></p> 