

How to put your model together / Mode d'assemblage de votre modèle.
 Anweisungen für den Zusammenbau des Modells / Methode voor het
 in elkaar zetten van Uw model / Så här sätter Du ihop modellen / Per
 montare il vostro modello / Näin kootaan malli.

Symbols used in assembly diagrams / Symboles employés sur les diagrammes d'assemblage.
 In den Zusammenstellungsskizzen verwendete Zeichen / Tekens die in de monteringsdiagrammen
 gebruikt worden / Teckenförklaring till sammanfogningsdiagram / Simboli usati nello
 schema de montaggio / Asennuskuvioissa käytettyjen merkkien selitykset.



Cement parts together.
 Coller les pièces ensemble.
 Teile zusammenkleben.
 Cementeer de delen samen.
 Limma ihop delarna.
 Cementare le parti l'una con l'altra.
 Osat liimataan yhteen.



Do not cement together.
 Ne pas coller ensemble.
 Nicht zusammenkleben.
 Cementeer niet samen.
 Limma inte ihop delarna.
 Non cementare le parti.
 Osia ei liimata yhteen.



Choice of parts provided.
 Choix de pièces fournies.
 Mitgelieferte Auswahl an Teilen.
 Keuze van beschikbare onderdelen.
 Dessa delar medföljer för valfri användning.
 Particolari a scelta.
 Osien käyttö valinnanvaraista.



Cut with a sharp knife.
 Couper avec un couteau tranchant.
 Mit einem scharfen messer schneiden.
 Snijd met een scherp mes.
 Skär med en skarp kniv.
 Tagliare con un coltello ben affilato.
 Leikatkaa terävällä veitsellä.



Shape with a hot knife.
 Former au canif chaud.
 Mit einem heißen Messer formen.
 Vorm met een heet mes.
 Forma med varm kniv.
 Modellare con la lama di un coltello, riscaldato.
 Muovattaa kuumalla veitsellä.

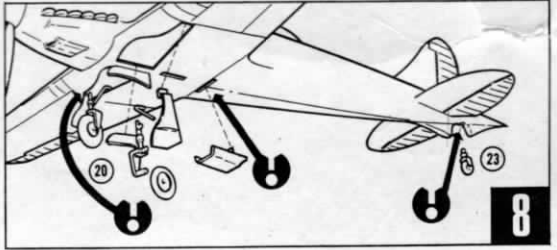
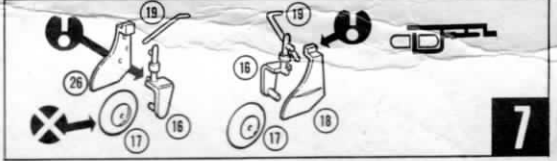
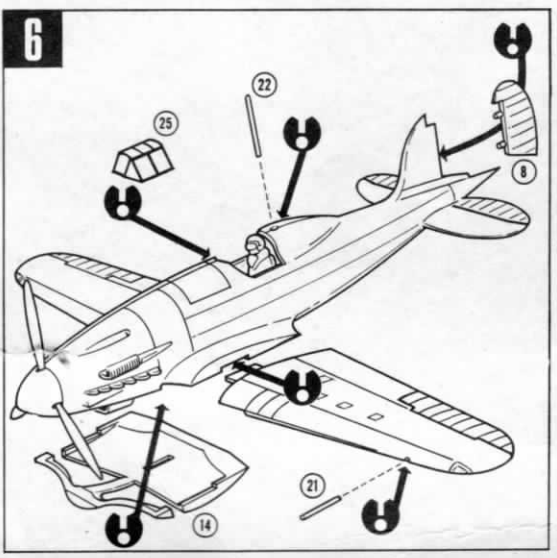
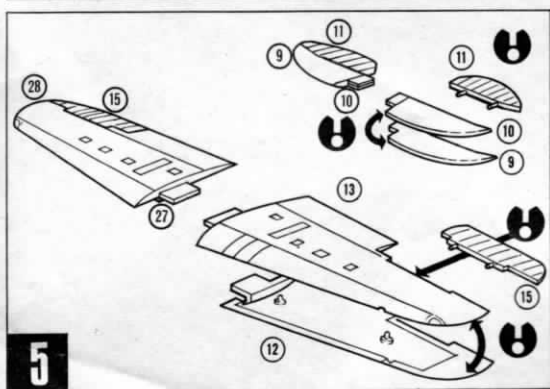
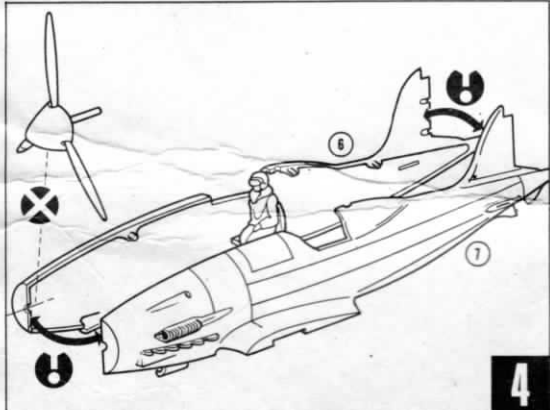
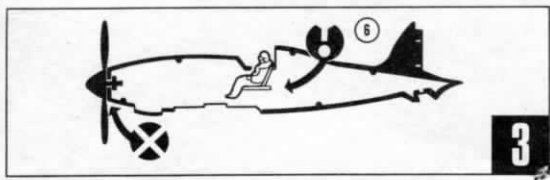
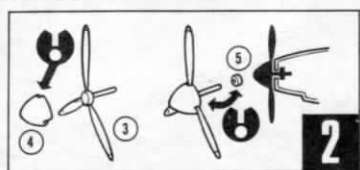

Aircraft Colour Guide

MACCHI MC202 'FOLGORE' (Lightning)



363 sq.C.T., 150 Gruppo C.T., 53 Stormo C.T.,
Benghazi, Libya, July 1942

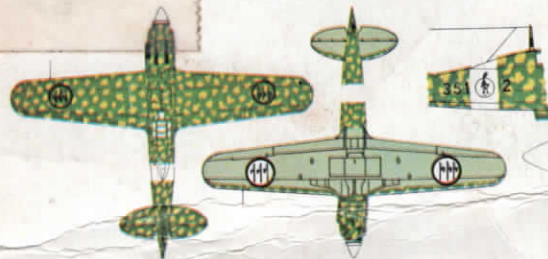
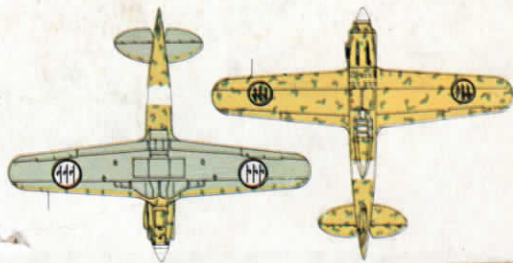

351 Sq.C.T., 155 Gruppo C.T., 51 Stormo C.T.





Multi lingual assembly pictures! Choice of markings and parts for one of two different models.



Gemakkelijk te volgen Nederlandse instructies. Keuze uit merktekens voor twee verschillende modellen!



Übersichtliche deutsche Zusammenbauanleitung. Markierungswahl für zwei verschiedene Modelle!



Instructions faciles à suivre en Français. Choix de couleurs et pièces pour un des deux modèles!



Instruktioner på svenska. Markeringar för två olika modeller att välja mellan.



Suomenkieliset ohjeet. Kahdet valinnanvaraiset tunnukset.



Istruzioni in Italiano facili da eseguire, decals e mascheramento a scelta!

MACCHI MC202

FOLGORE



F225F

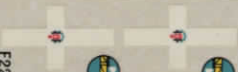

363



2

363



2

351



2

2



351